

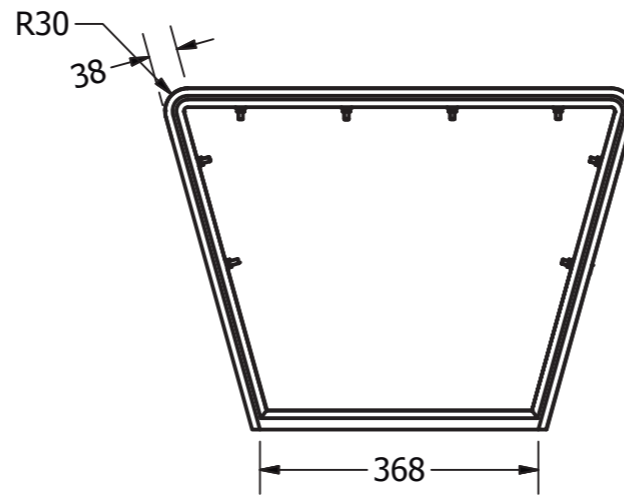

PROPUESTA 1

LÁMINAS TÉCNICAS

RENDERS

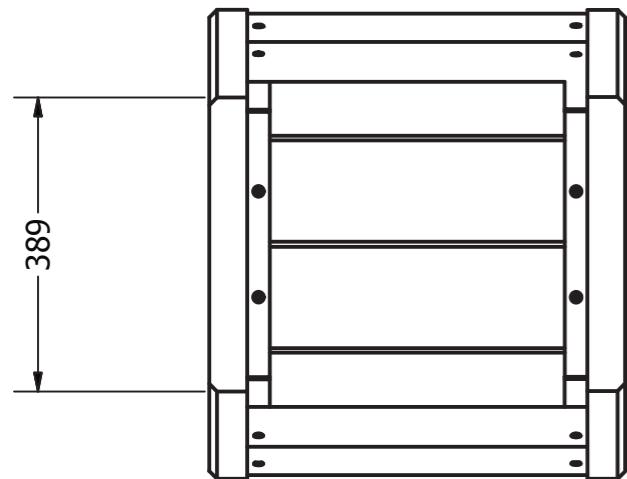
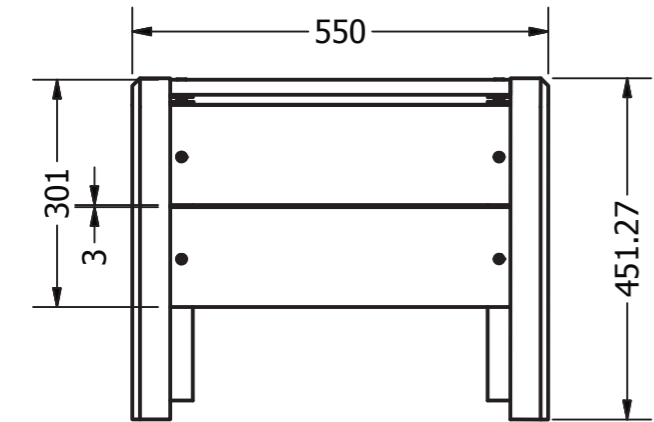
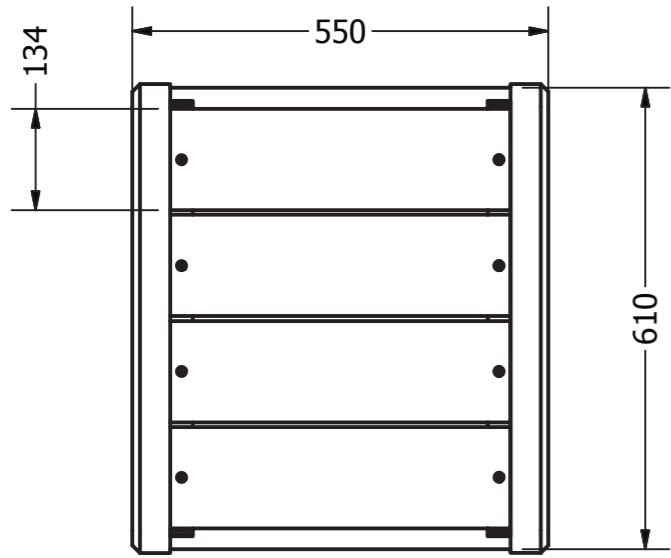

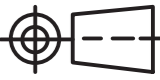
PUCE-FADA- DISEÑO		TFC DE DISEÑO DE PRODUCTOS		
Realizado por: Diego Guevara	Dimensiones: mm	Contiene: Dimensiones Banca Unipersonal	Escala: 1:10	
Revisado por: Mst. María Dolores Cevallos	Fecha: 19/07/2017			
CPE INEN 003 1989 ECUADOR				

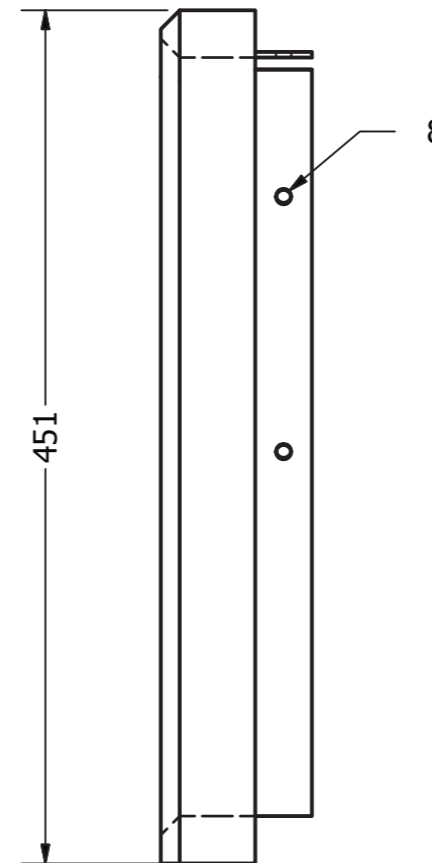
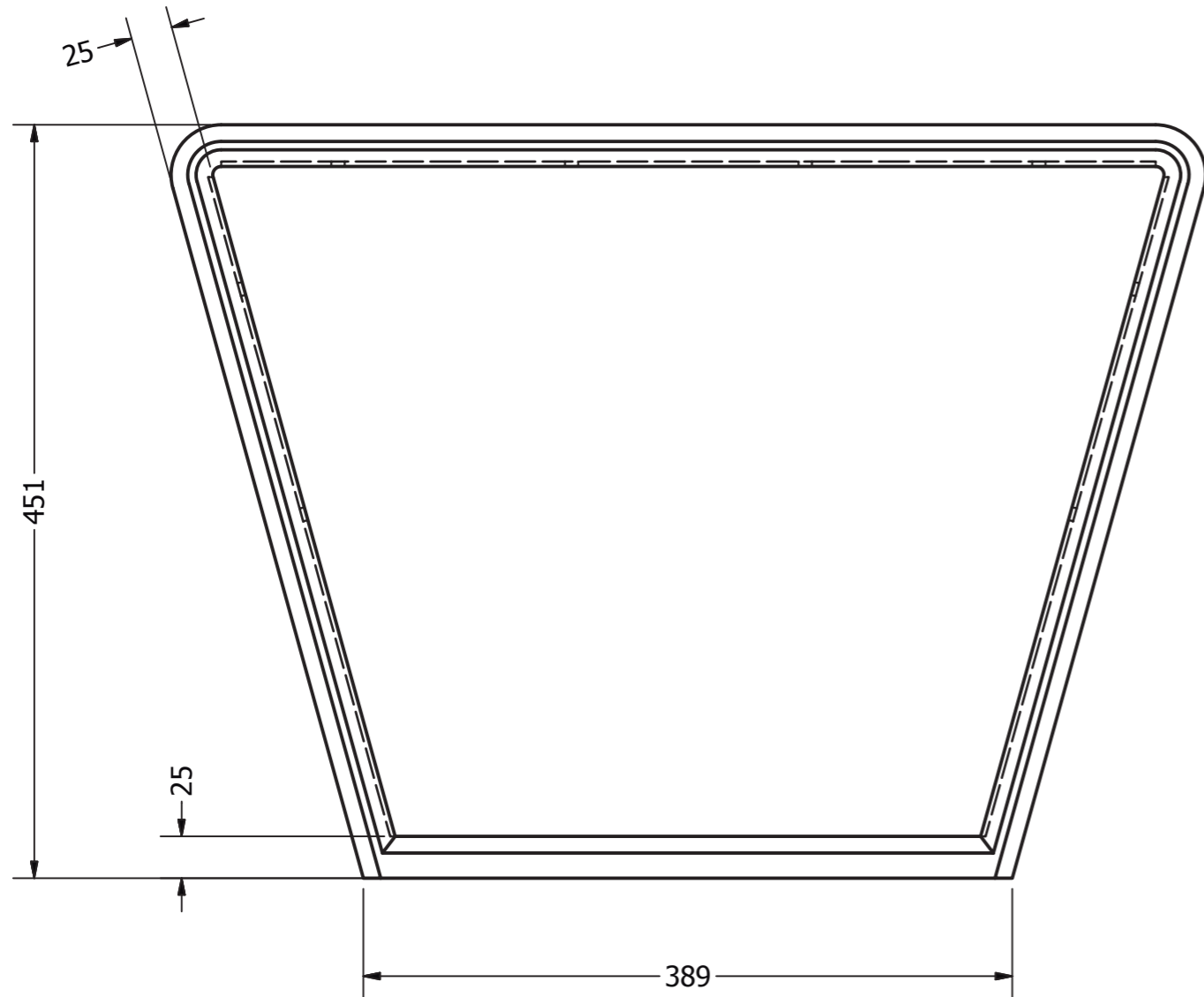
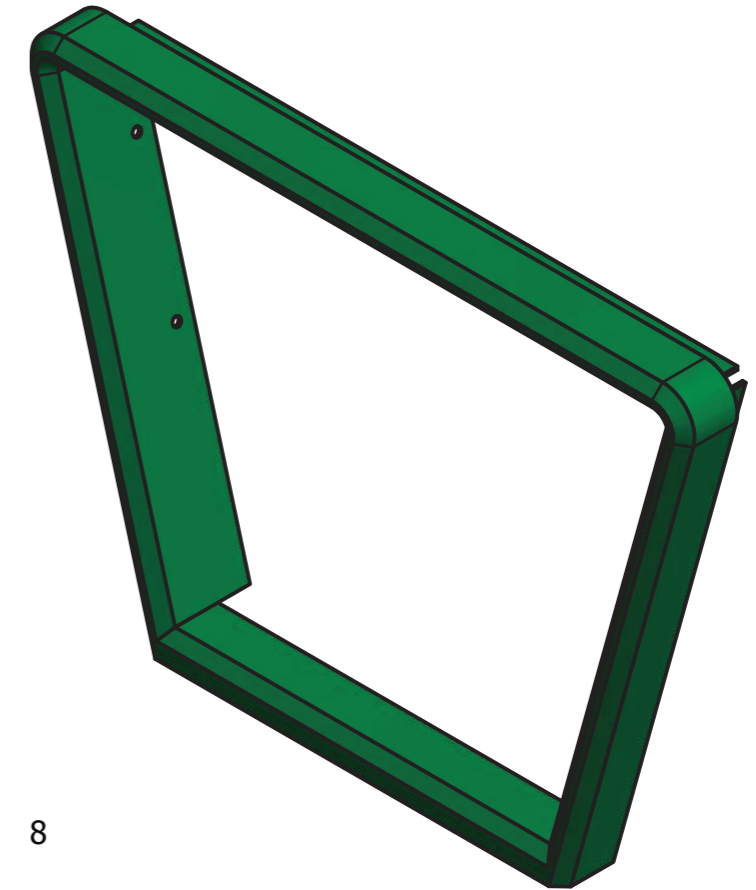
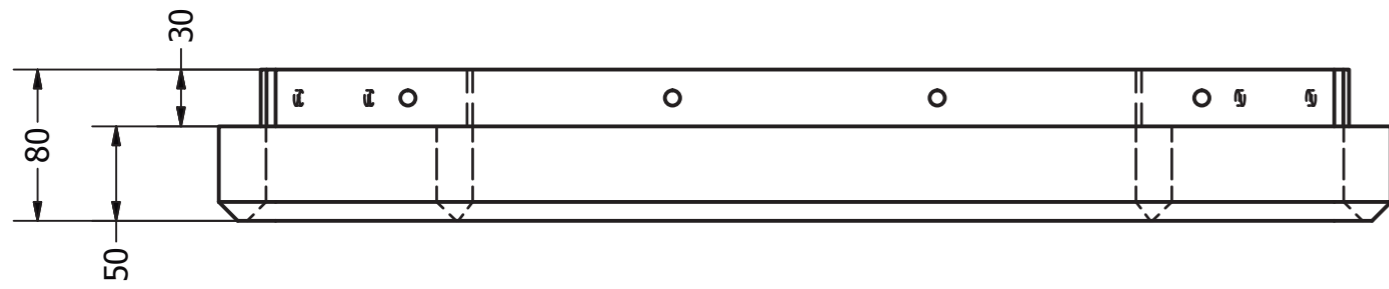

PUCE-FADA- DISEÑO		TFC DE DISEÑO DE PRODUCTOS		
Realizado por: Diego Guevara	Dimensiones: mm	Contiene: Dimensiones Perfil de Banca Unipersonal	Escala: 1:5	
Revisado por: Mst. María Dolores Cevallos	Fecha: 19/07/2017			
CPE INEN 003 1989 ECUADOR				

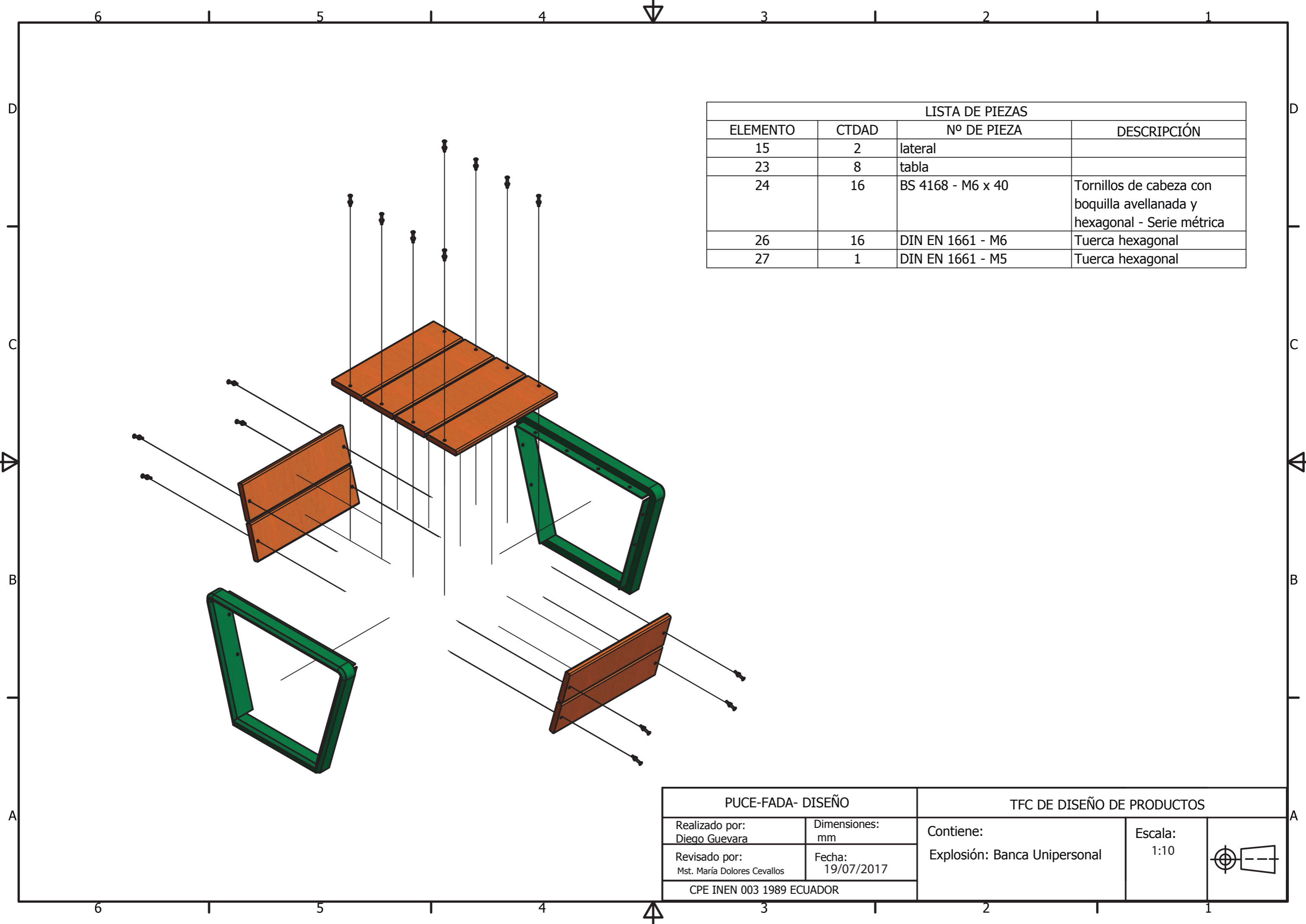

LISTA DE PIEZAS			
ELEMENTO	CTDAD	Nº DE PIEZA	DESCRIPCIÓN
15	2	lateral	
23	8	tabla	
24	16	BS 4168 - M6 x 40	Tornillos de cabeza con boquilla avellanada y hexagonal - Serie métrica
26	16	DIN EN 1661 - M6	Tuerca hexagonal
27	1	DIN EN 1661 - M5	Tuerca hexagonal

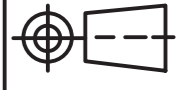
PUCE-FADA- DISEÑO		TFC DE DISEÑO DE PRODUCTOS		
Realizado por: Diego Guevara	Dimensiones: mm	Contiene: Explosión: Banca Unipersonal	Escala: 1:10	
Revisado por: Mst. María Dolores Cevallos	Fecha: 19/07/2017			
CPE INEN 003 1989 ECUADOR				

DETALLE DE IMPLANTACIÓN

Soldadura TIC, Tubo de 50mm a la estructura del tubo del mobiliario , con profundidad de 40 cm en una base de concreto de 50 cm x 50 cm x 30 cm.

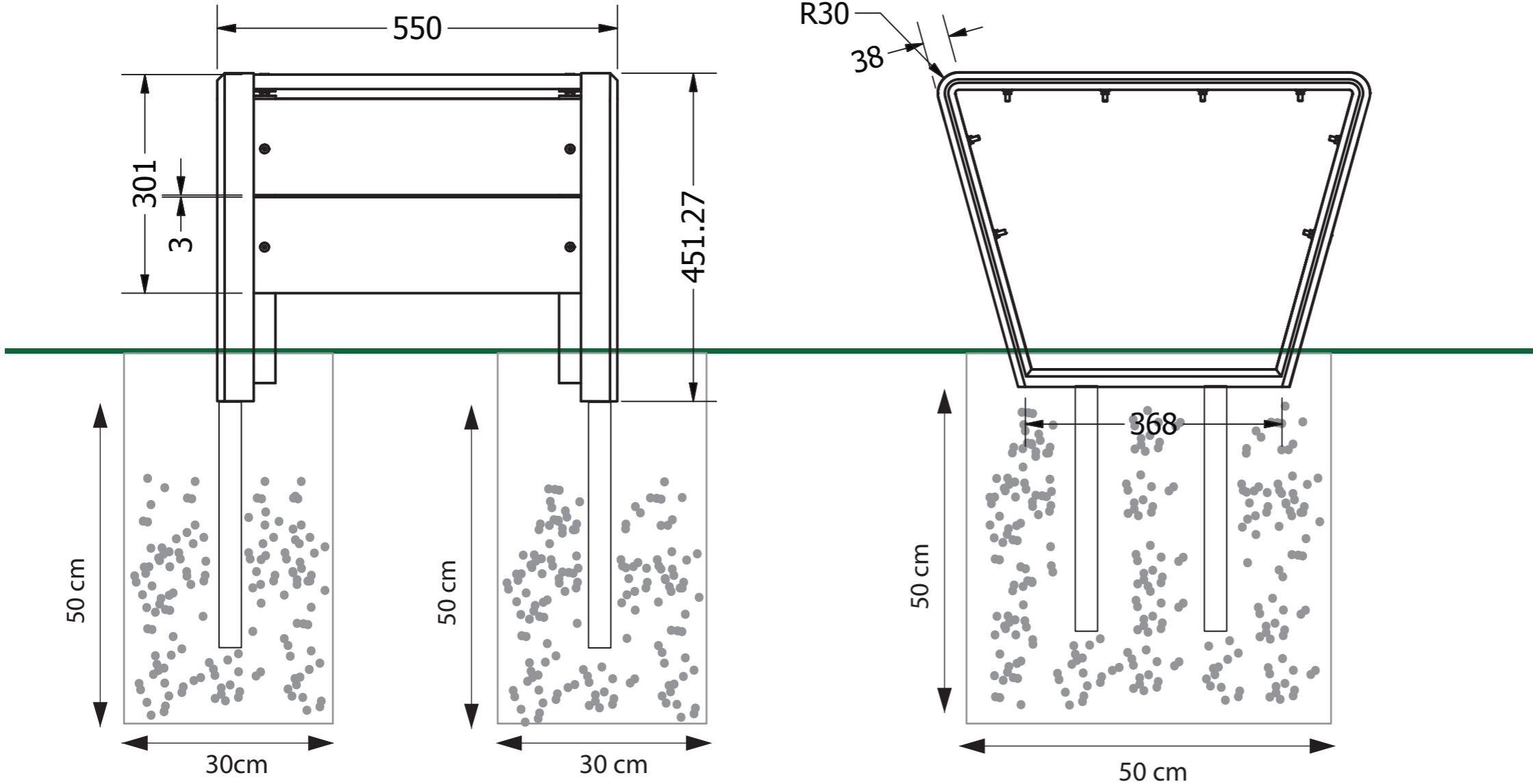

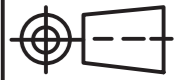
PUCE-FADA- DISEÑO		TFC DE DISEÑO DE PRODUCTOS		
Realizado por: Diego Guevara	Dimensiones: cm	Contiene: Implatación: Banca Unipersonal	Escala: 1:10	
Revisado por: Mst. María Dolores Cevallos	Fecha: 19/07/2017			
CPE INEN 003 1989 ECUADOR				

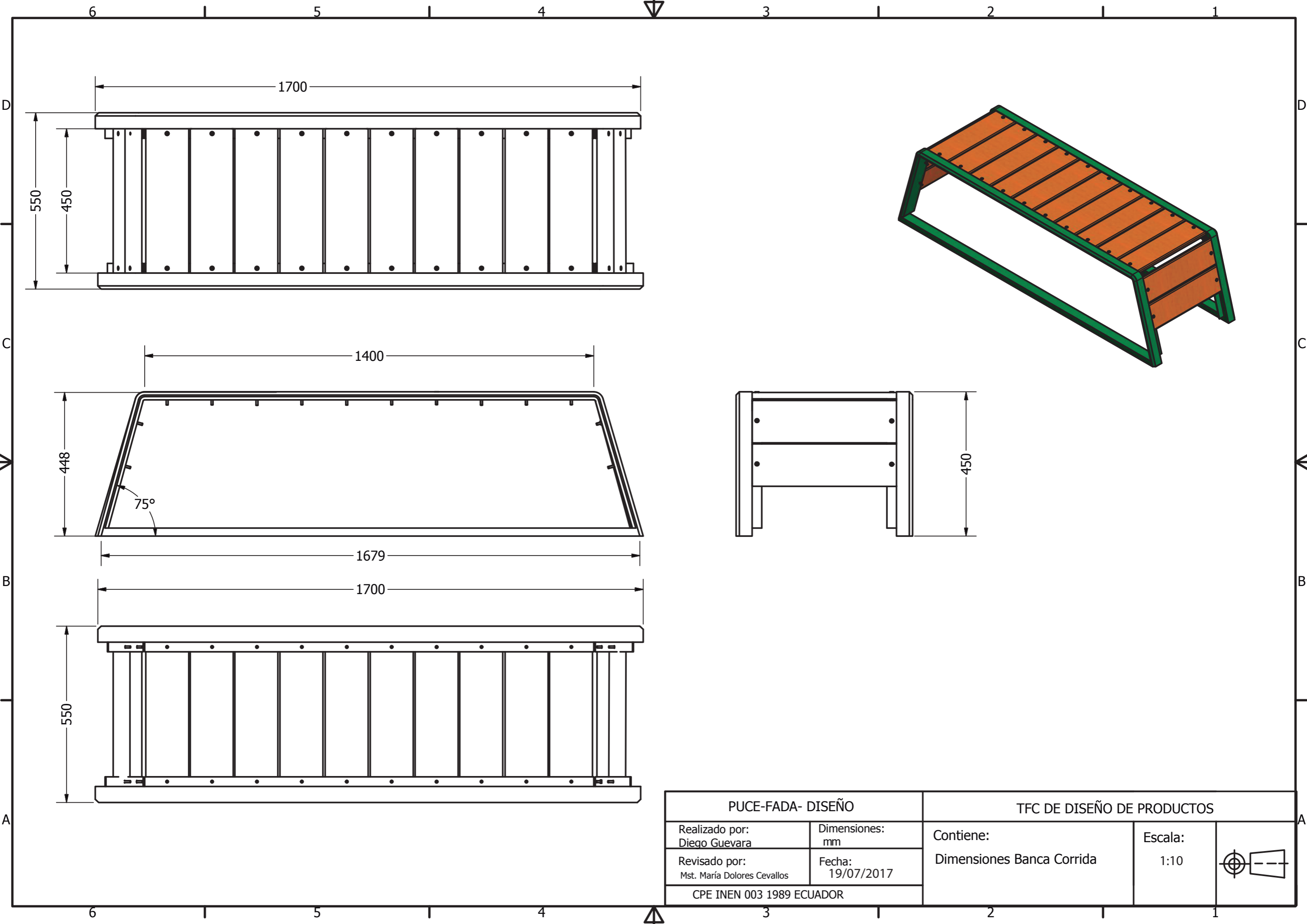

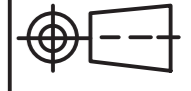
PUCE-FADA- DISEÑO		TFC DE DISEÑO DE PRODUCTOS		
Realizado por: Diego Guevara	Dimensiones: mm	Contiene: Dimensiones Banca Corrida	Escala: 1:10	
Revisado por: Mst. María Dolores Cevallos	Fecha: 19/07/2017			
CPE INEN 003 1989 ECUADOR				

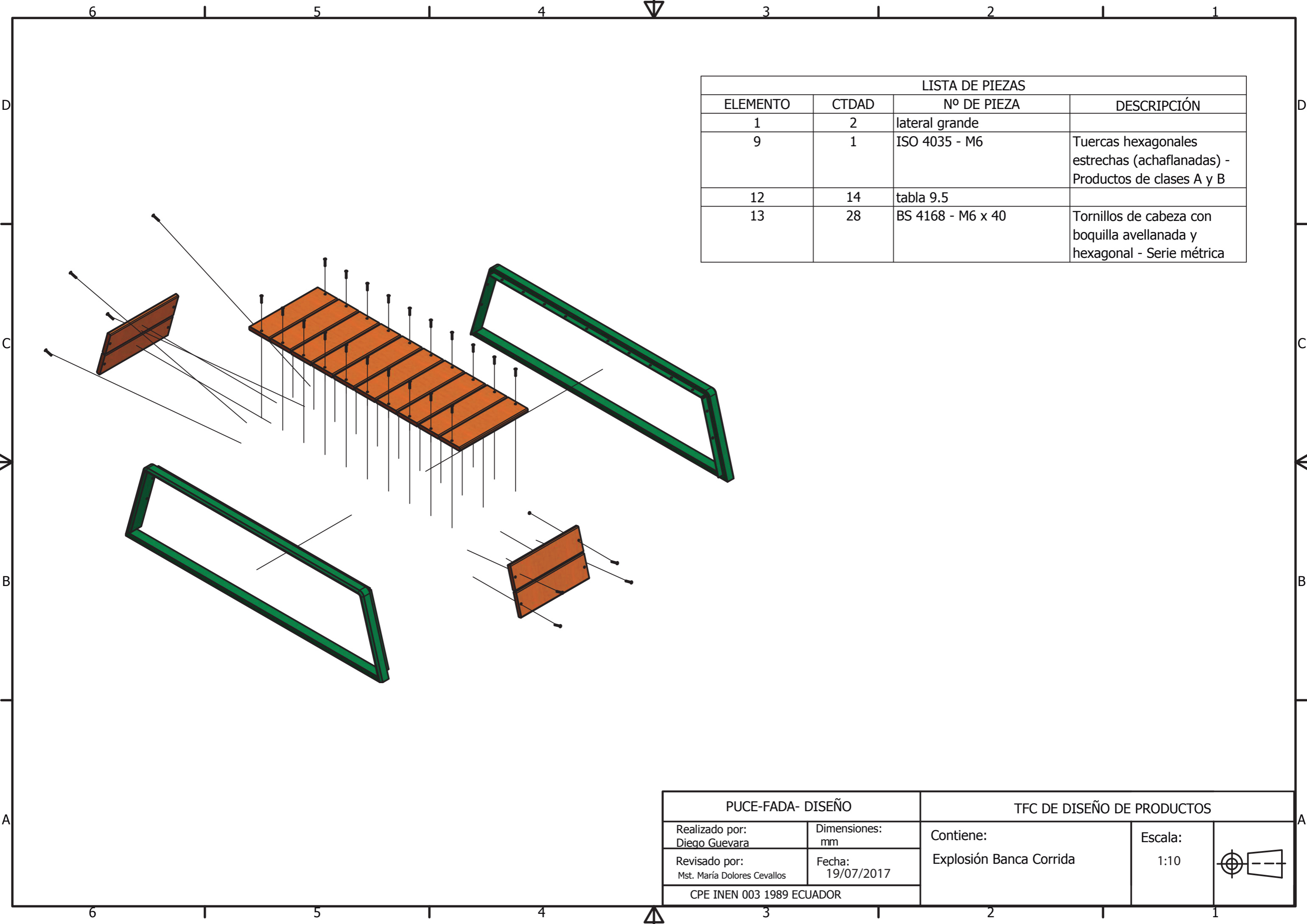

LISTA DE PIEZAS			
ELEMENTO	CTDAD	Nº DE PIEZA	DESCRIPCIÓN
1	2	lateral grande	
9	1	ISO 4035 - M6	Tuercas hexagonales estrechas (achaflanadas) - Productos de clases A y B
12	14	tabla 9.5	
13	28	BS 4168 - M6 x 40	Tornillos de cabeza con boquilla avellanada y hexagonal - Serie métrica

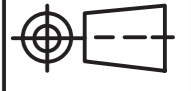
PUCE-FADA- DISEÑO		TFC DE DISEÑO DE PRODUCTOS		
Realizado por: Diego Guevara	Dimensiones: mm	Contiene: Explosión Banca Corrida	Escala: 1:10	
Revisado por: Mst. María Dolores Cevallos	Fecha: 19/07/2017			
CPE INEN 003 1989 ECUADOR				

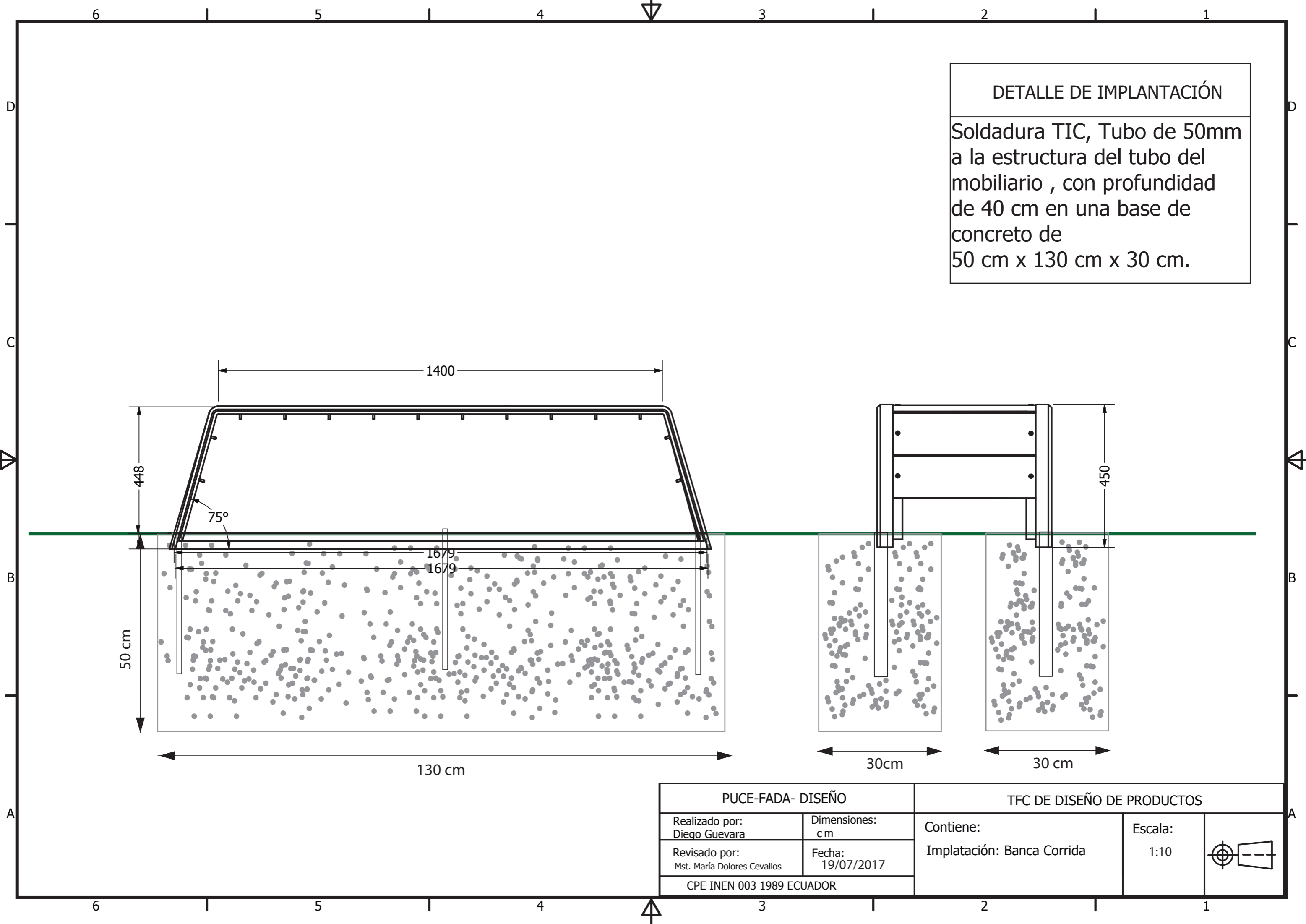

DETALLE DE IMPLANTACIÓN

Soldadura TIC, Tubo de 50mm a la estructura del tubo del mobiliario, con profundidad de 40 cm en una base de concreto de 50 cm x 130 cm x 30 cm.

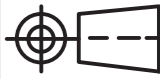
PUCE-FADA- DISEÑO		TFC DE DISEÑO DE PRODUCTOS		
Realizado por: Diego Guevara	Dimensiones: c m	Contiene: Implatación: Banca Corrida	Escala: 1:10	
Revisado por: Mst. María Dolores Cevallos	Fecha: 19/07/2017			
CPE INEN 003 1989 ECUADOR				

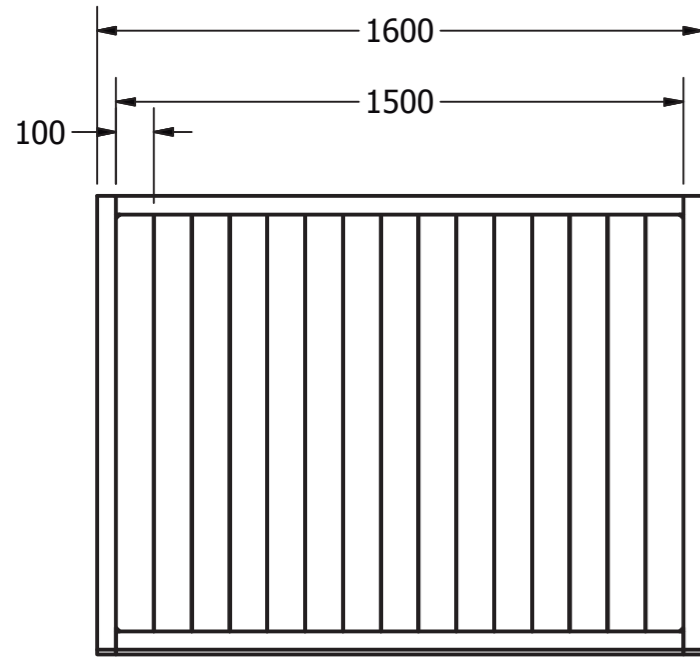

VISTA SUPERIOR

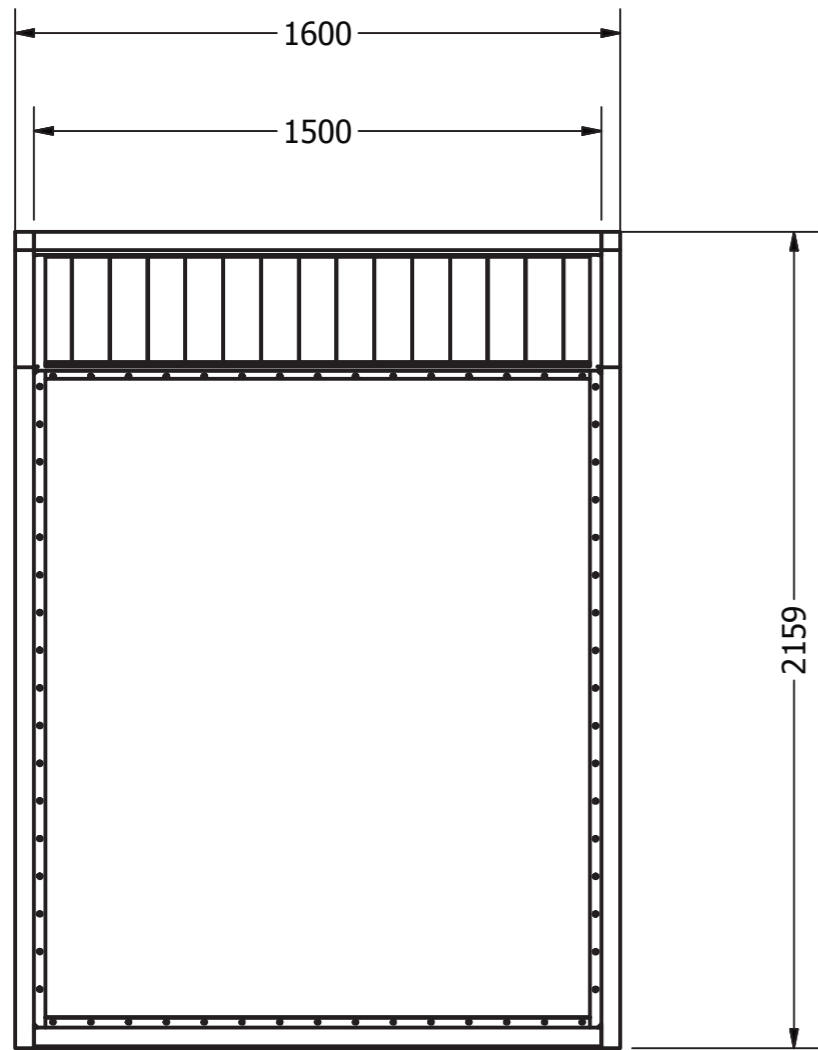

VISTA FRONTAL

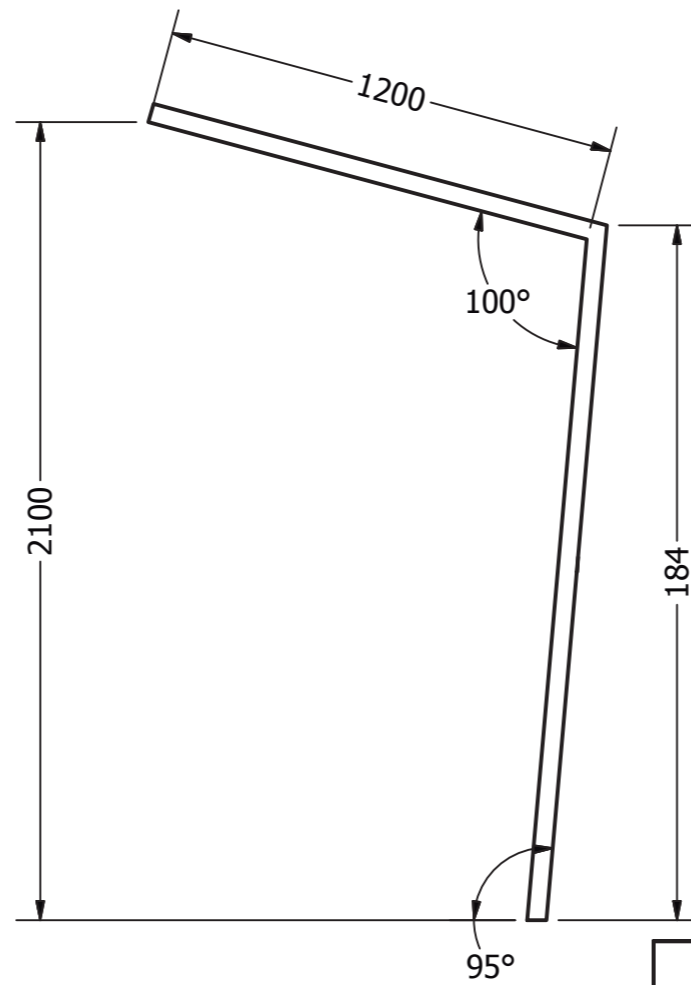

VISTA LATERAL DERECHA

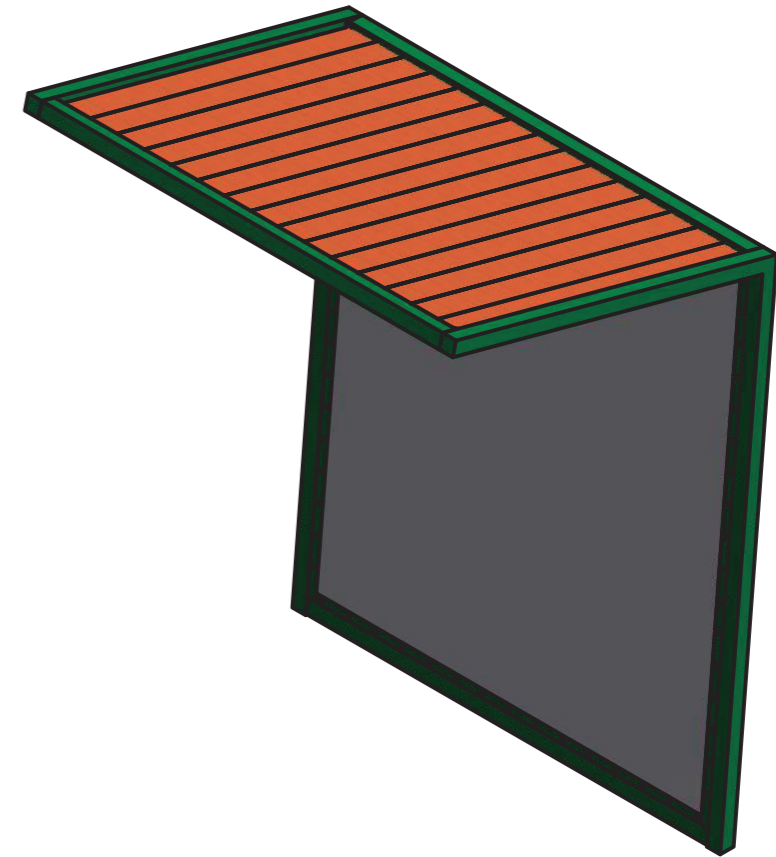

PUCE-FADA- DISEÑO		TFC DE DISEÑO DE PRODUCTOS		
Realizado por: Diego Guevara	Dimensiones: mm	Contiene: Dimensiones Protector Climático	Escala: 1:20	
Revisado por: Mst. María Dolores Cevallos	Fecha: 19/07/2017			
CPE INEN 003 1989 ECUADOR				

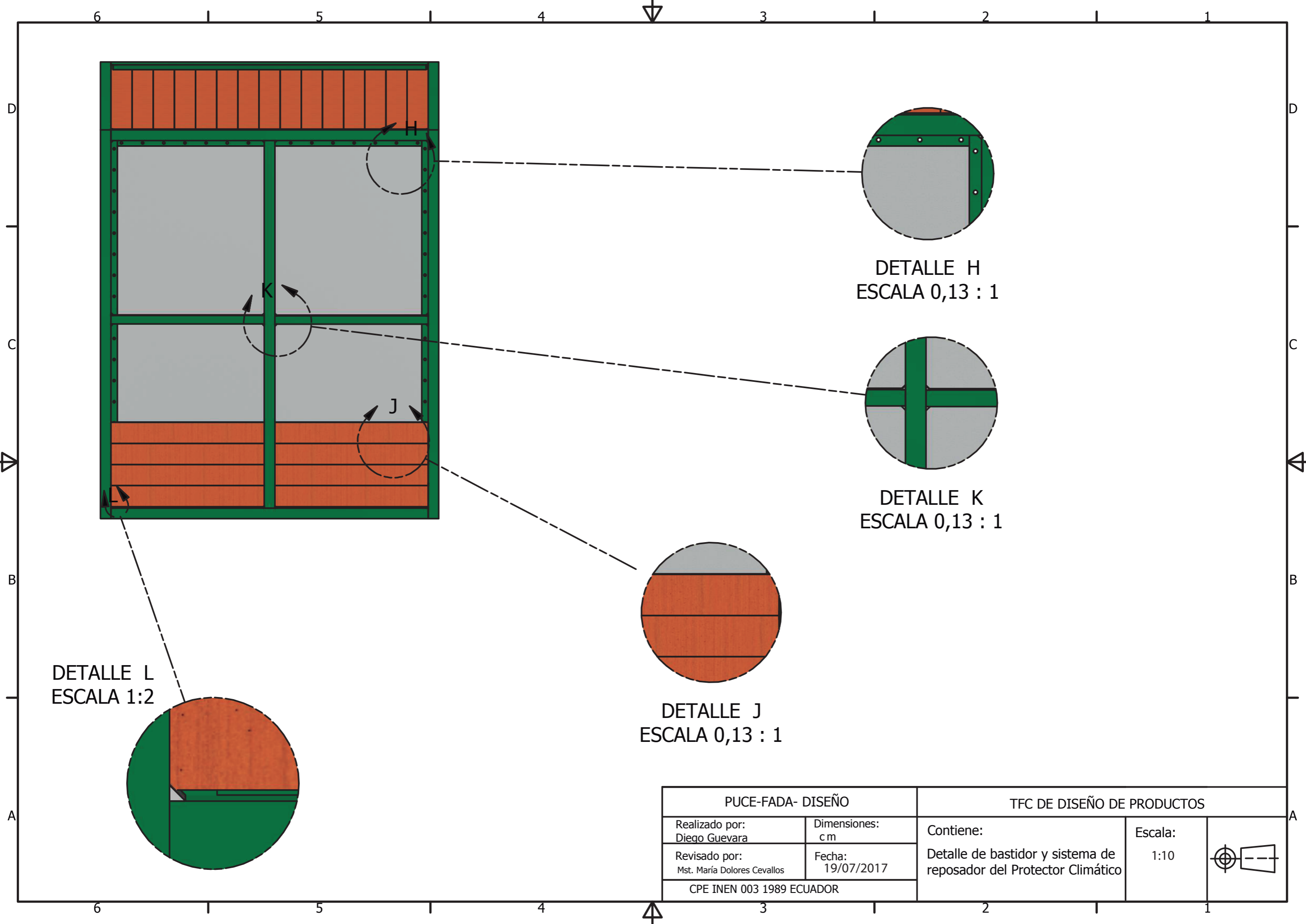

DETALLE H
ESCALA 0,13 : 1

DETALLE K
ESCALA 0,13 : 1

DETALLE J
ESCALA 0,13 : 1

DETALLE L
ESCALA 1:2

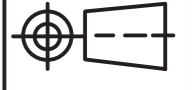
PUCE-FADA- DISEÑO		TFC DE DISEÑO DE PRODUCTOS		
Realizado por: Diego Guevara	Dimensiones: cm	Contiene: Detalle de bastidor y sistema de repositor del Protector Climático	Escala: 1:10	
Revisado por: Mst. María Dolores Cevallos	Fecha: 19/07/2017			
CPE INEN 003 1989 ECUADOR				

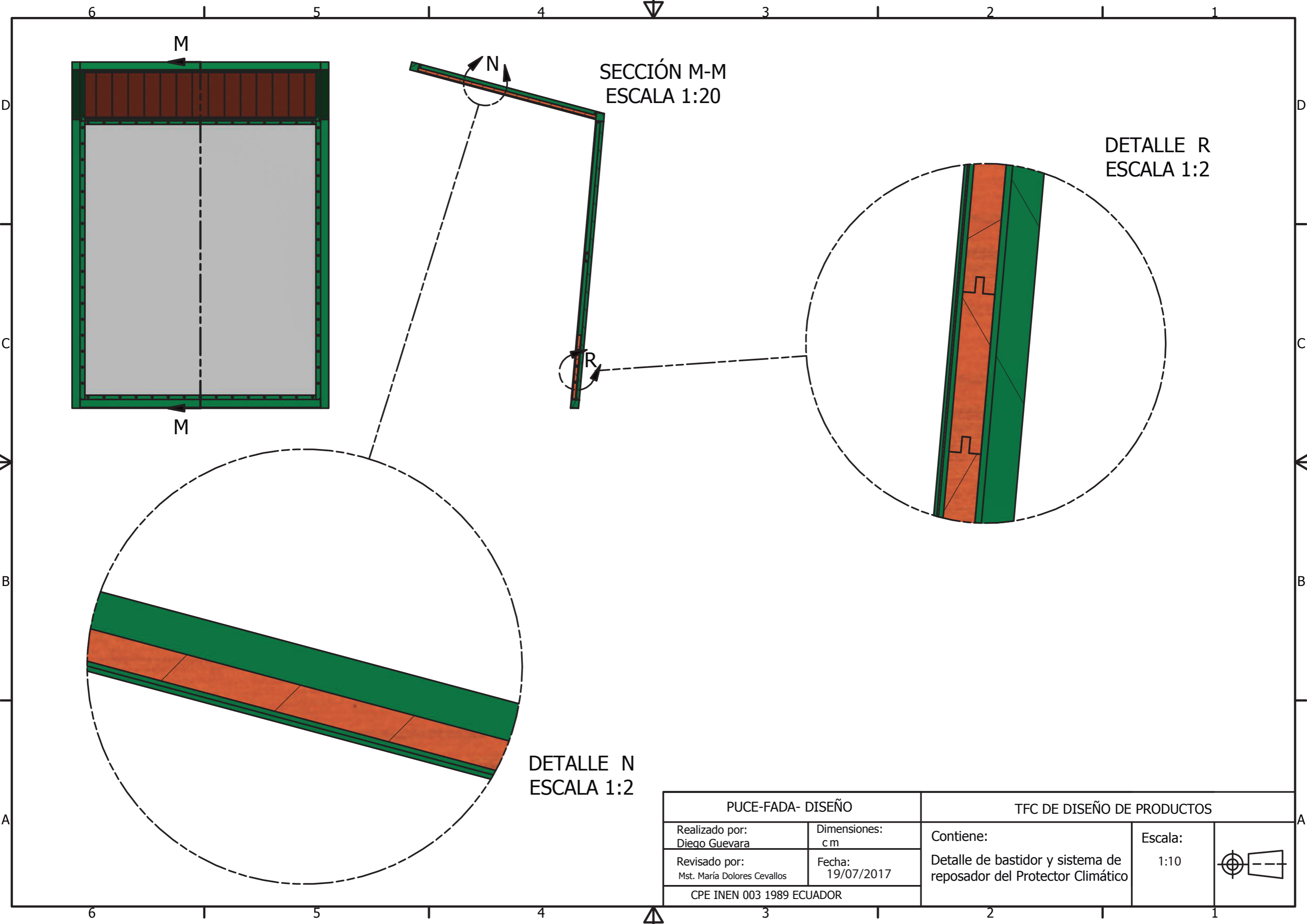

SECCIÓN M-M
ESCALA 1:20

DETALLE R
ESCALA 1:2

DETALLE N
ESCALA 1:2

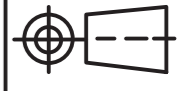
PUCE-FADA- DISEÑO		TFC DE DISEÑO DE PRODUCTOS		
Realizado por: Diego Guevara	Dimensiones: cm	Contiene: Detalle de bastidor y sistema de reposador del Protector Climático	Escala: 1:10	
Revisado por: Mst. María Dolores Cevallos	Fecha: 19/07/2017			
CPE INEN 003 1989 ECUADOR				

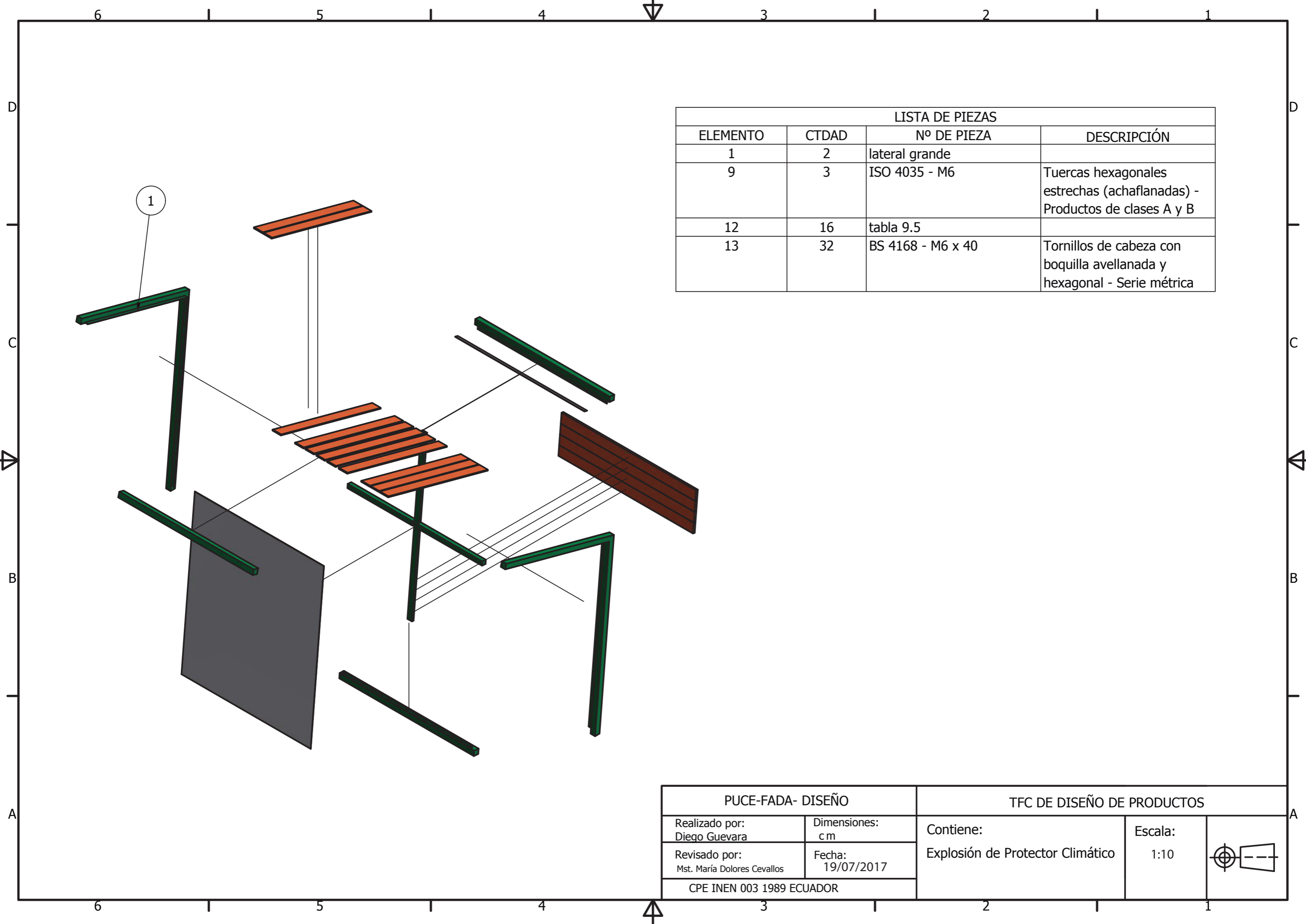

LISTA DE PIEZAS			
ELEMENTO	CTDAD	Nº DE PIEZA	DESCRIPCIÓN
1	2	lateral grande	
9	3	ISO 4035 - M6	Tuercas hexagonales estrechas (achaflanadas) - Productos de clases A y B
12	16	tabla 9.5	
13	32	BS 4168 - M6 x 40	Tornillos de cabeza con boquilla avellanada y hexagonal - Serie métrica

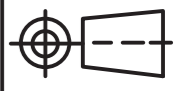
PUCE-FADA- DISEÑO		TFC DE DISEÑO DE PRODUCTOS		
Realizado por: Diego Guevara	Dimensiones: cm	Contiene: Explosión de Protector Climático	Escala: 1:10	
Revisado por: Mst. María Dolores Cevallos	Fecha: 19/07/2017			
CPE INEN 003 1989 ECUADOR				

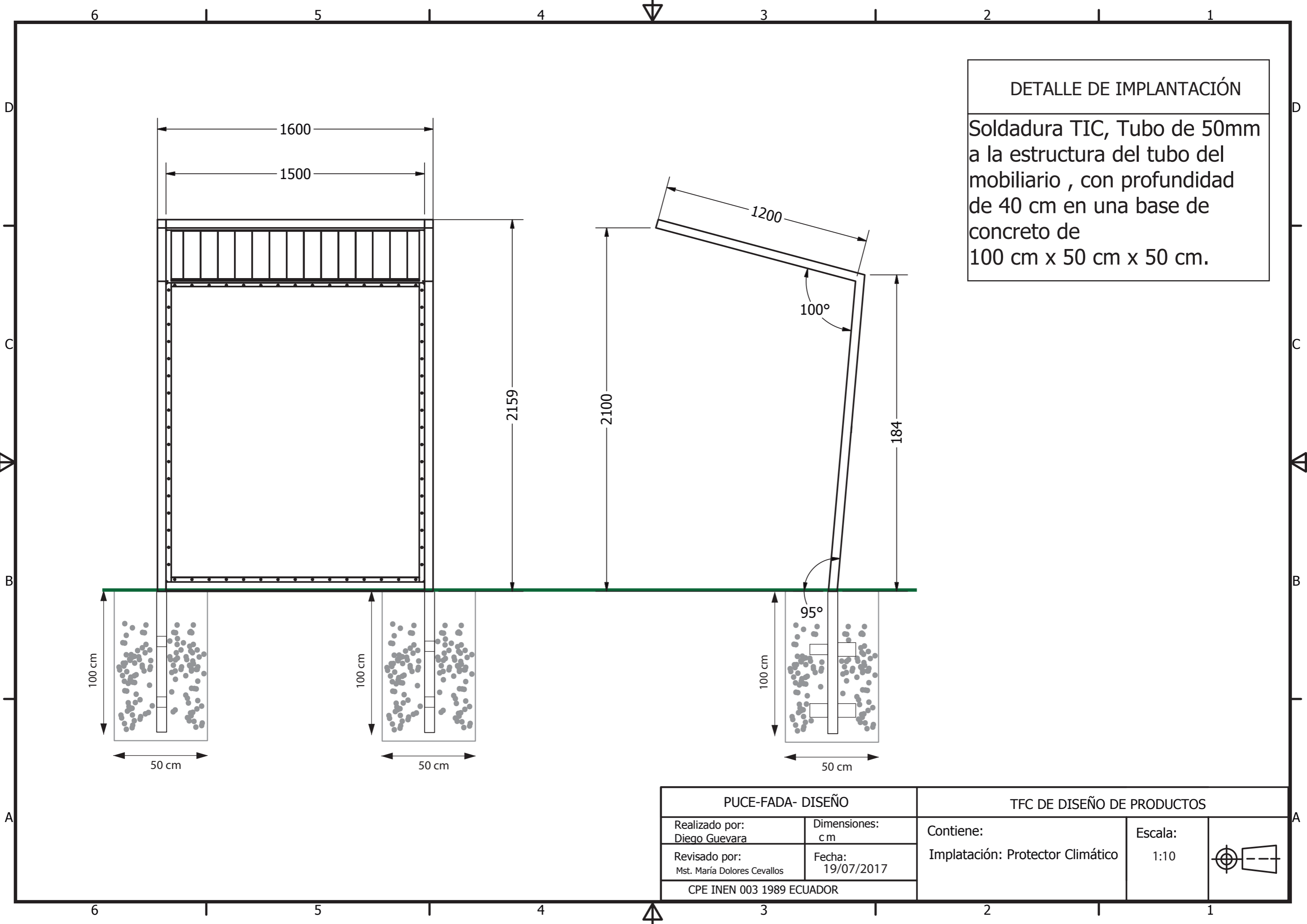

DETALLE DE IMPLANTACIÓN

Soldadura TIC, Tubo de 50mm a la estructura del tubo del mobiliario , con profundidad de 40 cm en una base de concreto de 100 cm x 50 cm x 50 cm.

PUCE-FADA- DISEÑO		TFC DE DISEÑO DE PRODUCTOS		
Realizado por: Diego Guevara	Dimensiones: c m	Contiene:	Escala:	
Revisado por: Mst. María Dolores Cevallos	Fecha: 19/07/2017	Implatación: Protector Climático	1:10	
CPE INEN 003 1989 ECUADOR				

POSTURAS ANTROPOMÉTRICAS
 POSTURA ALTURA RODILLA : 550 mm
 POSTURA ALTURA POPLITEA : 380 mm
 POSTURA ANCHURA DE CODOS: 620 mm

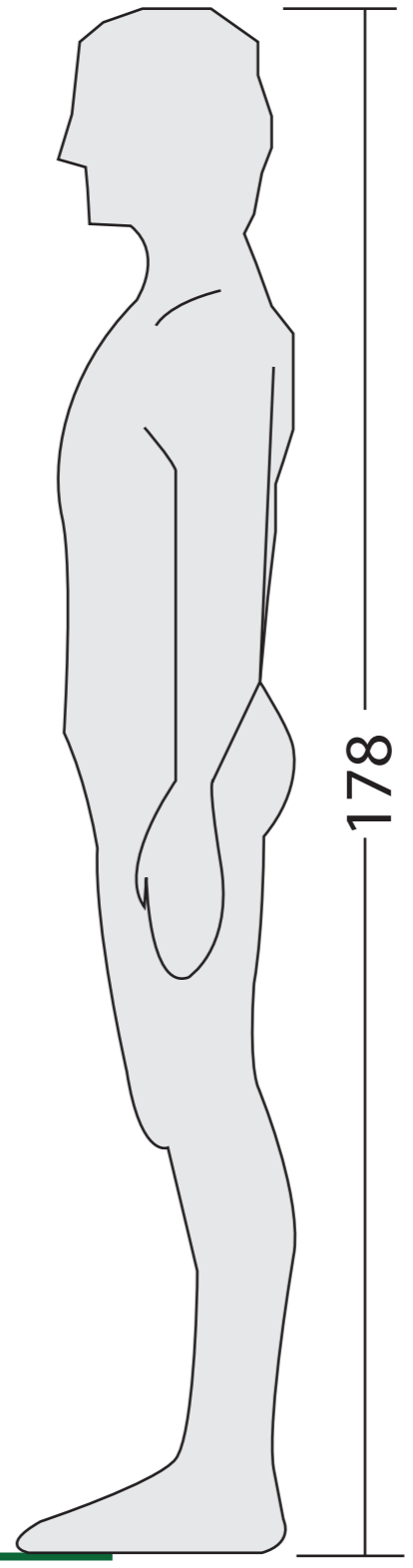
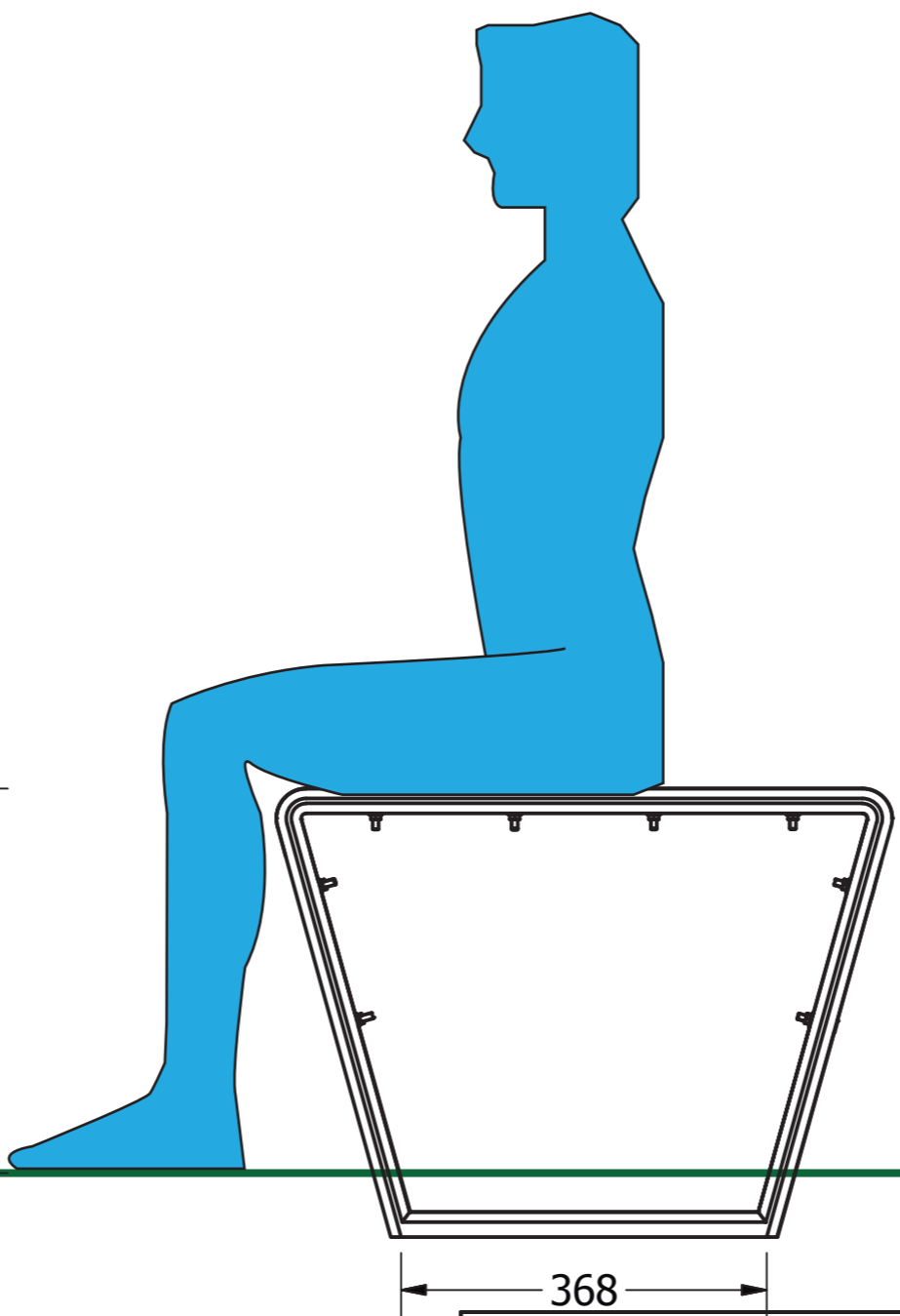
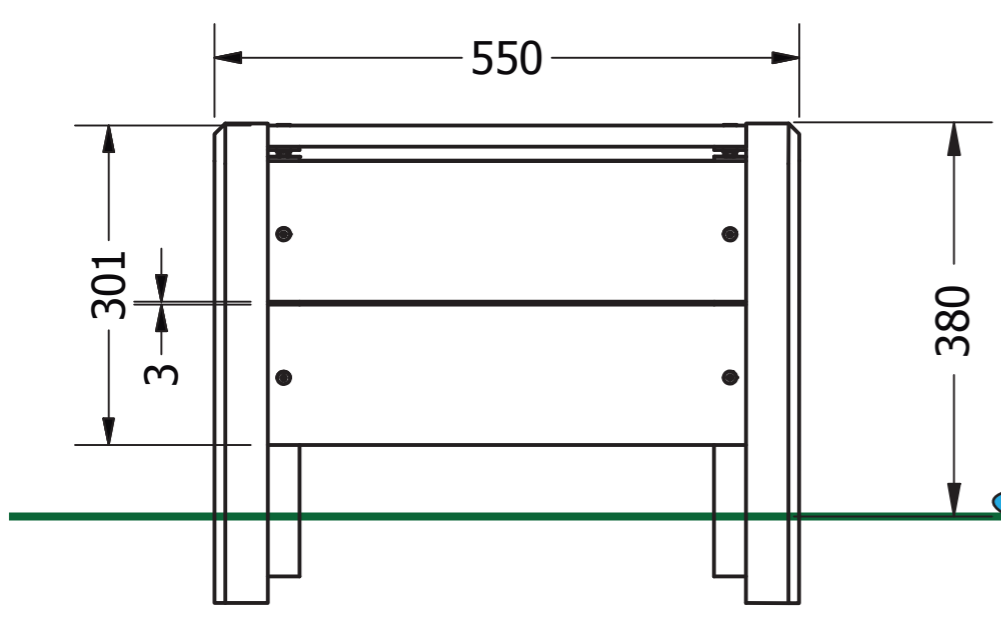

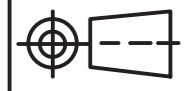
PUCE-FADA- DISEÑO		TFC DE DISEÑO DE PRODUCTOS	
Realizado por: Diego Guevara	Dimensiones: cm	Contiene: Análisis Antropométrico Banca Unipersonal	Escala: 1:10
Revisado por: Mst. María Dolores Cevallos	Fecha: 19/07/2017		
CPE INEN 003 1989 ECUADOR			

POSTURAS ANTROPOMÉTRICAS
 POSTURA ALTURA RODILLA : 550 mm
 POSTURA ALTURA POPLITEA : 380 mm
 POSTURA ANCHURA DE CODOS: 620 mm

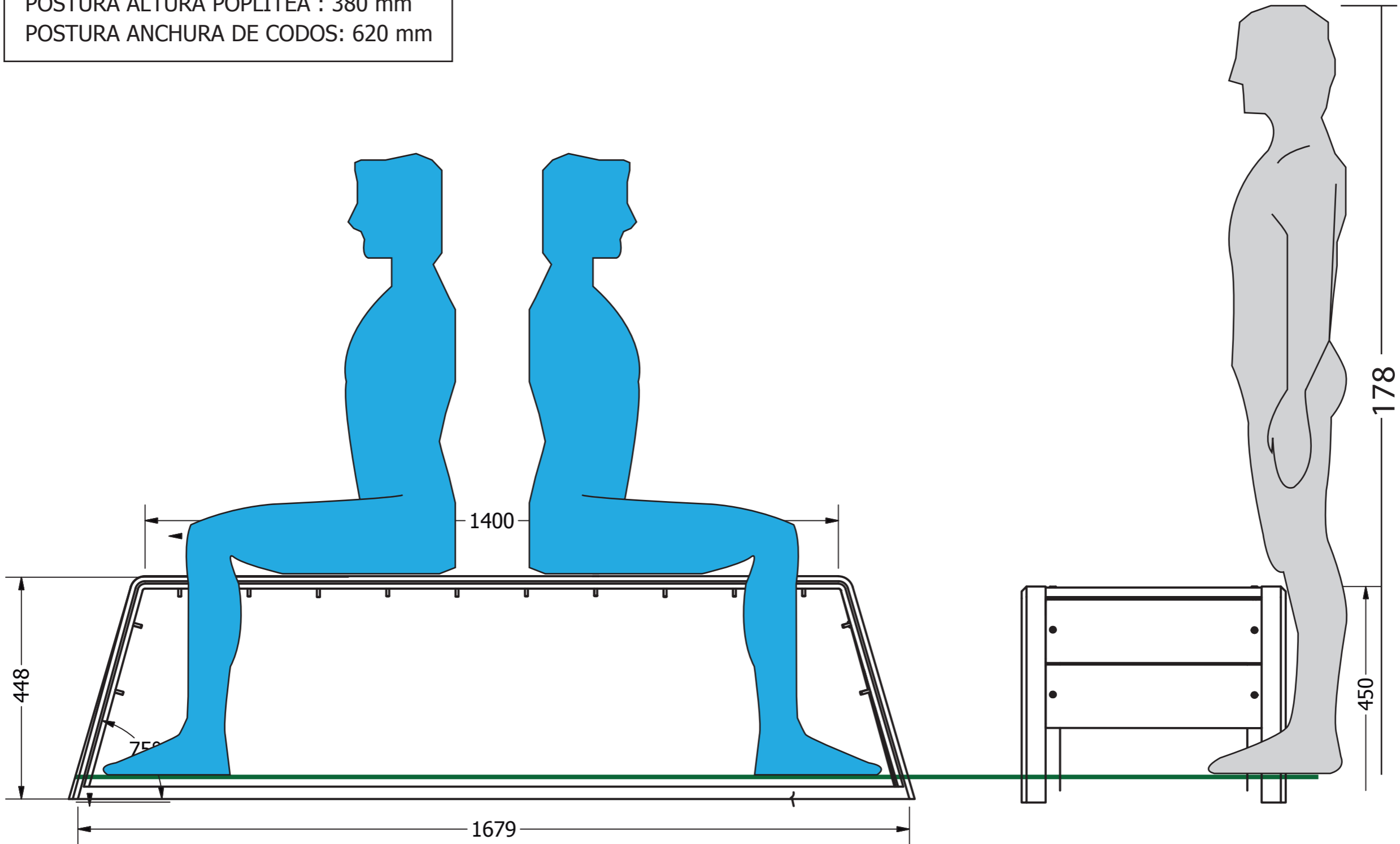

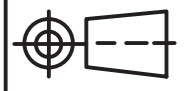
PUCE-FADA- DISEÑO		TFC DE DISEÑO DE PRODUCTOS		
Realizado por: Diego Guevara	Dimensiones: cm	Contiene: Análisis Antropométrico Banca Corrida	Escala: 1:10	
Revisado por: Mst. María Dolores Cevallos	Fecha: 19/07/2017			
CPE INEN 003 1989 ECUADOR				

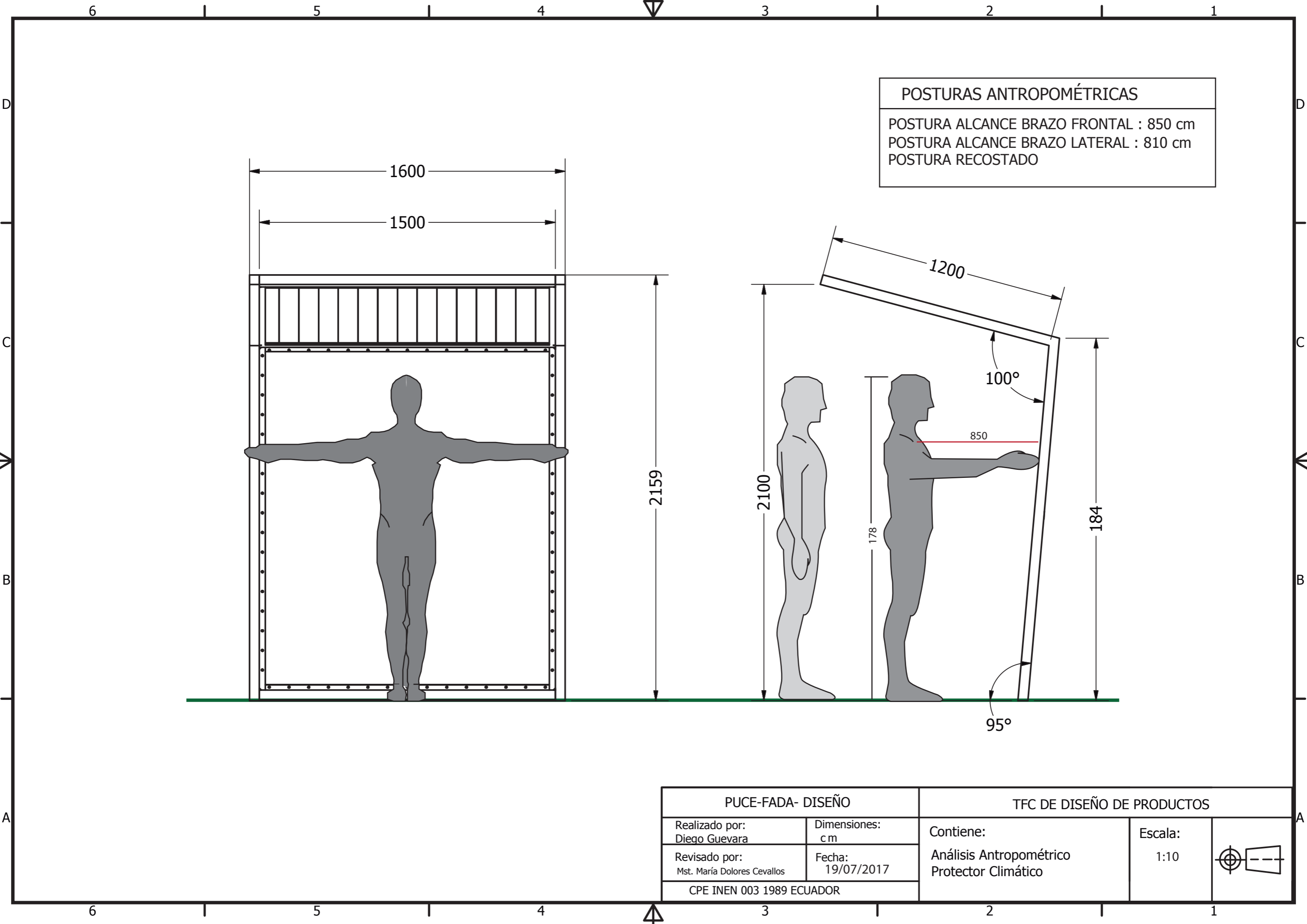

POSTURAS ANTROPOMÉTRICAS
 POSTURA ALCANCE BRAZO FRONTAL : 850 cm
 POSTURA ALCANCE BRAZO LATERAL : 810 cm
 POSTURA RECOSTADO

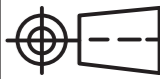
PUCE-FADA- DISEÑO		TFC DE DISEÑO DE PRODUCTOS		
Realizado por: Diego Guevara	Dimensiones: c m	Contiene: Análisis Antropométrico Protector Climático	Escala: 1:10	
Revisado por: Mst. María Dolores Cevallos	Fecha: 19/07/2017			
CPE INEN 003 1989 ECUADOR				



POSICIONES DE MOBILIARIO

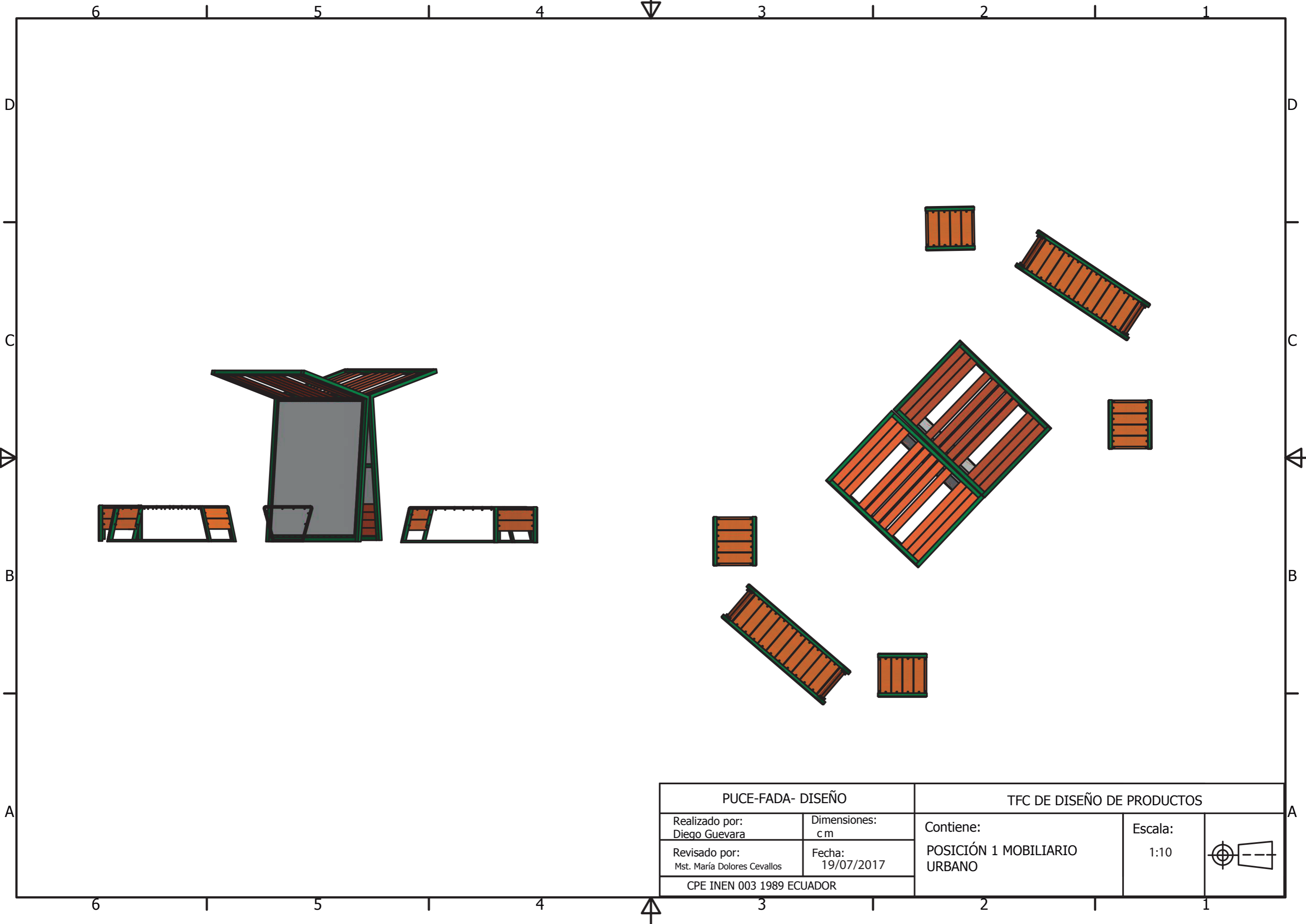

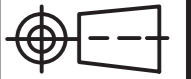
PUCE-FADA- DISEÑO		TFC DE DISEÑO DE PRODUCTOS		
Realizado por: Diego Guevara	Dimensiones: c m	Contiene: POSICIÓN 1 MOBILIARIO URBANO	Escala: 1:10	
Revisado por: Mst. María Dolores Cevallos	Fecha: 19/07/2017			
CPE INEN 003 1989 ECUADOR				

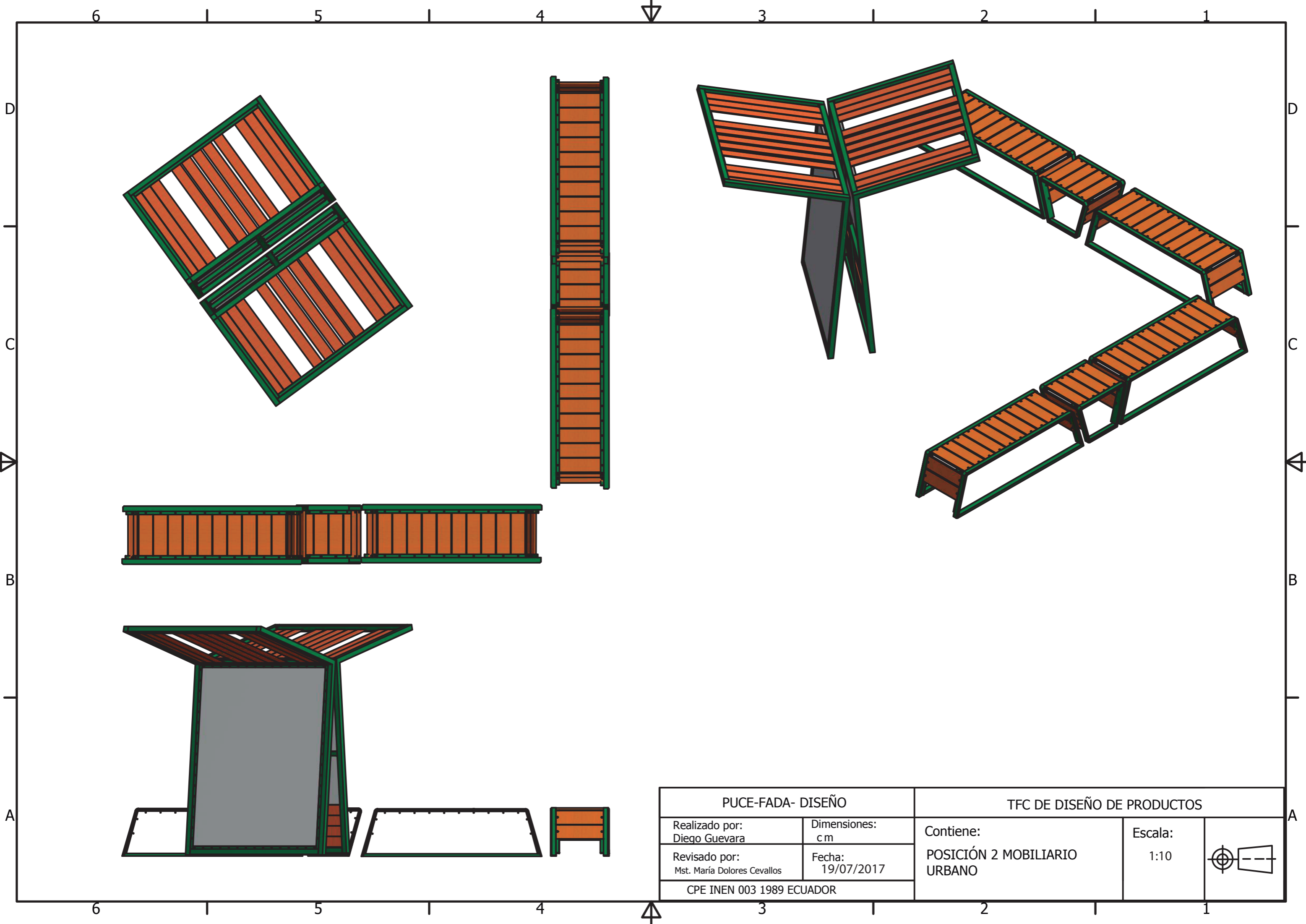

6 1 5 1 4 3 1 2 1 1

D D

C C

B B

A A

6 1 5 1 4 3 1 2 1 1

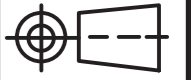
PUCE-FADA- DISEÑO		TFC DE DISEÑO DE PRODUCTOS		
Realizado por: Diego Guevara	Dimensiones: c m	Contiene: POSICIÓN 2 MOBILIARIO URBANO	Escala: 1:10	
Revisado por: Mst. María Dolores Cevallos	Fecha: 19/07/2017			
CPE INEN 003 1989 ECUADOR				



RENDERS



Handwritten graffiti in black ink on a white panel, featuring stylized characters and a small graphic element below.

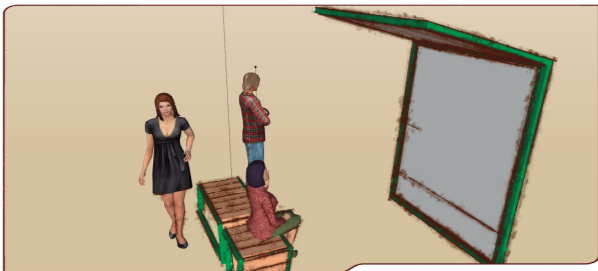
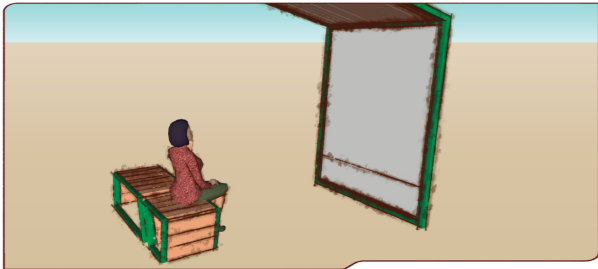
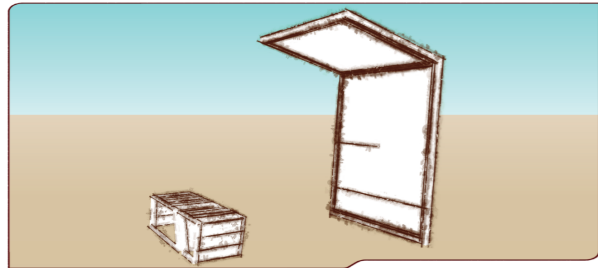

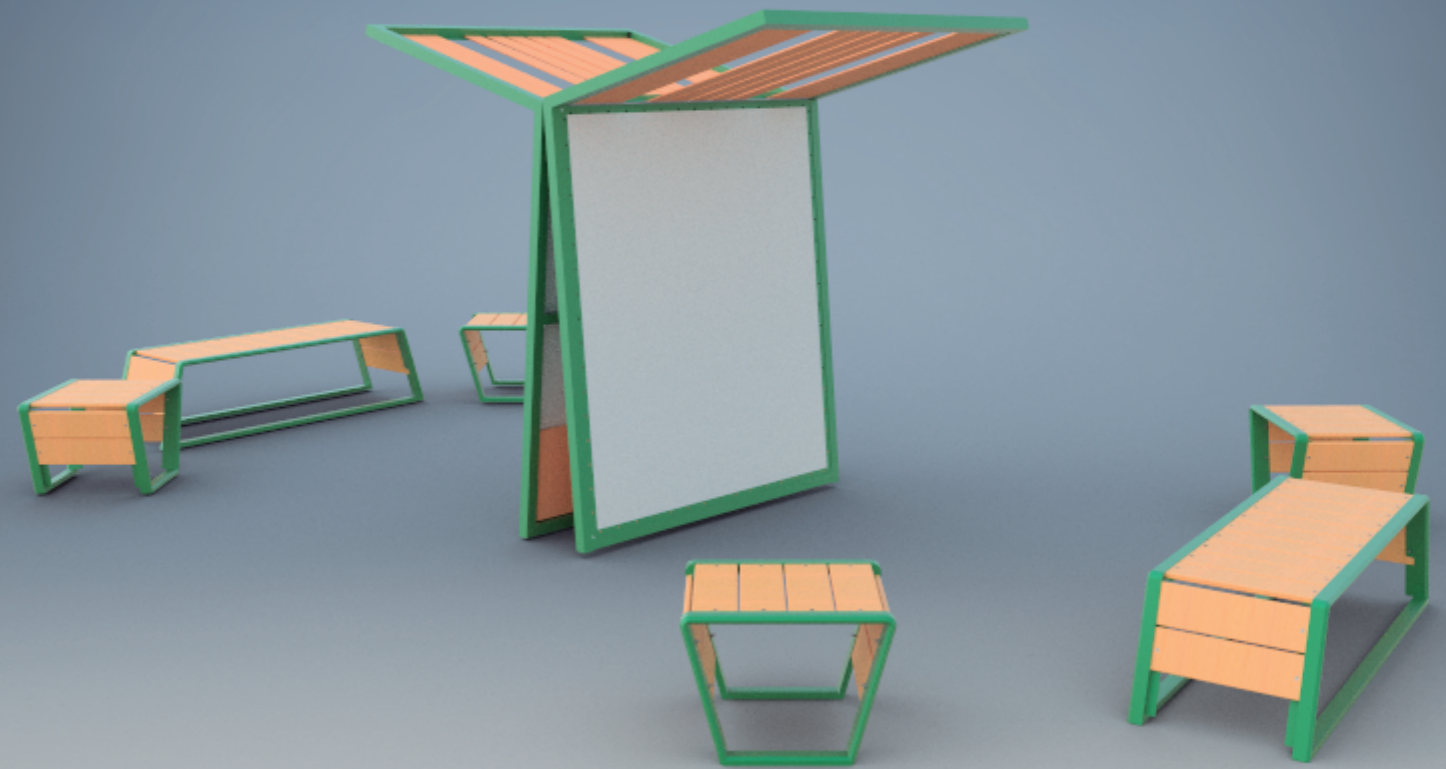
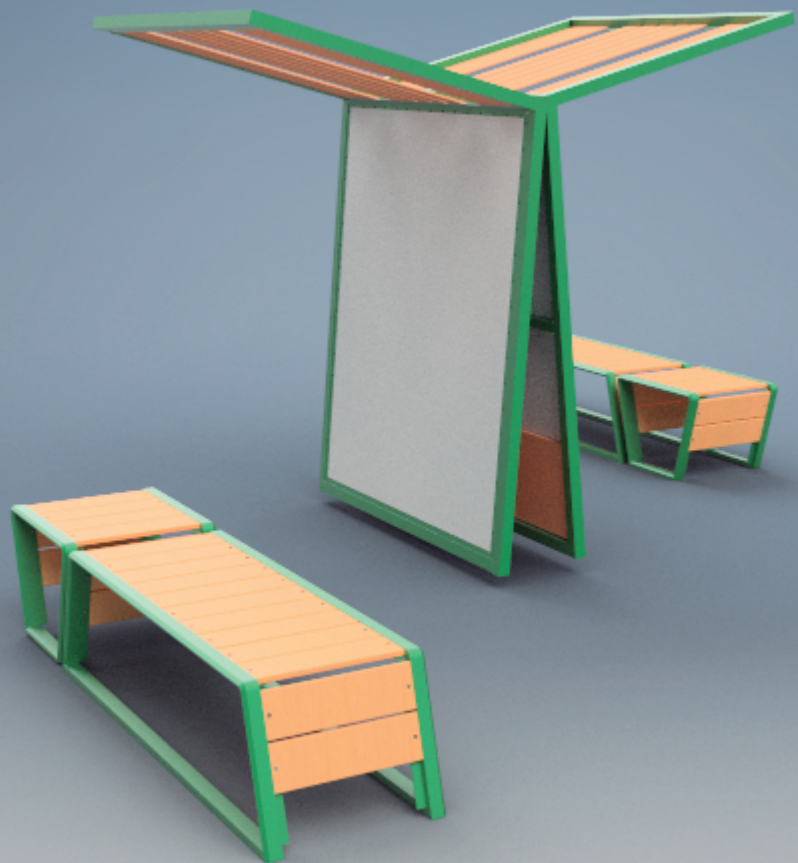
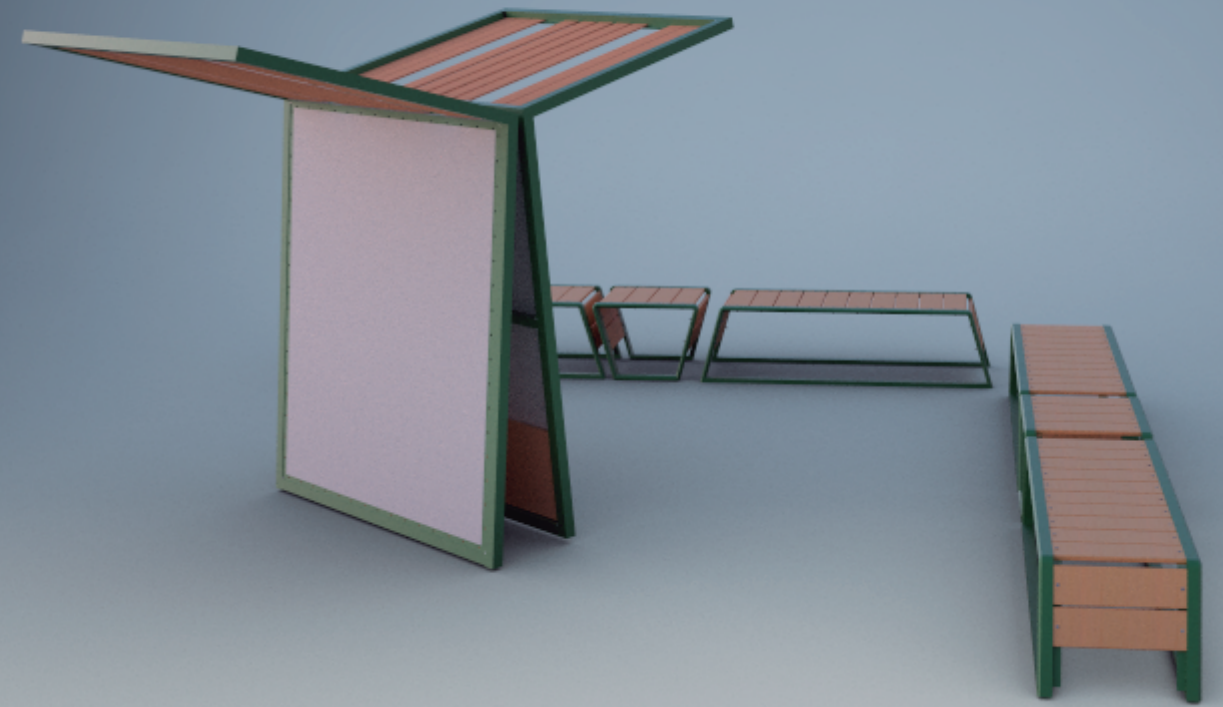
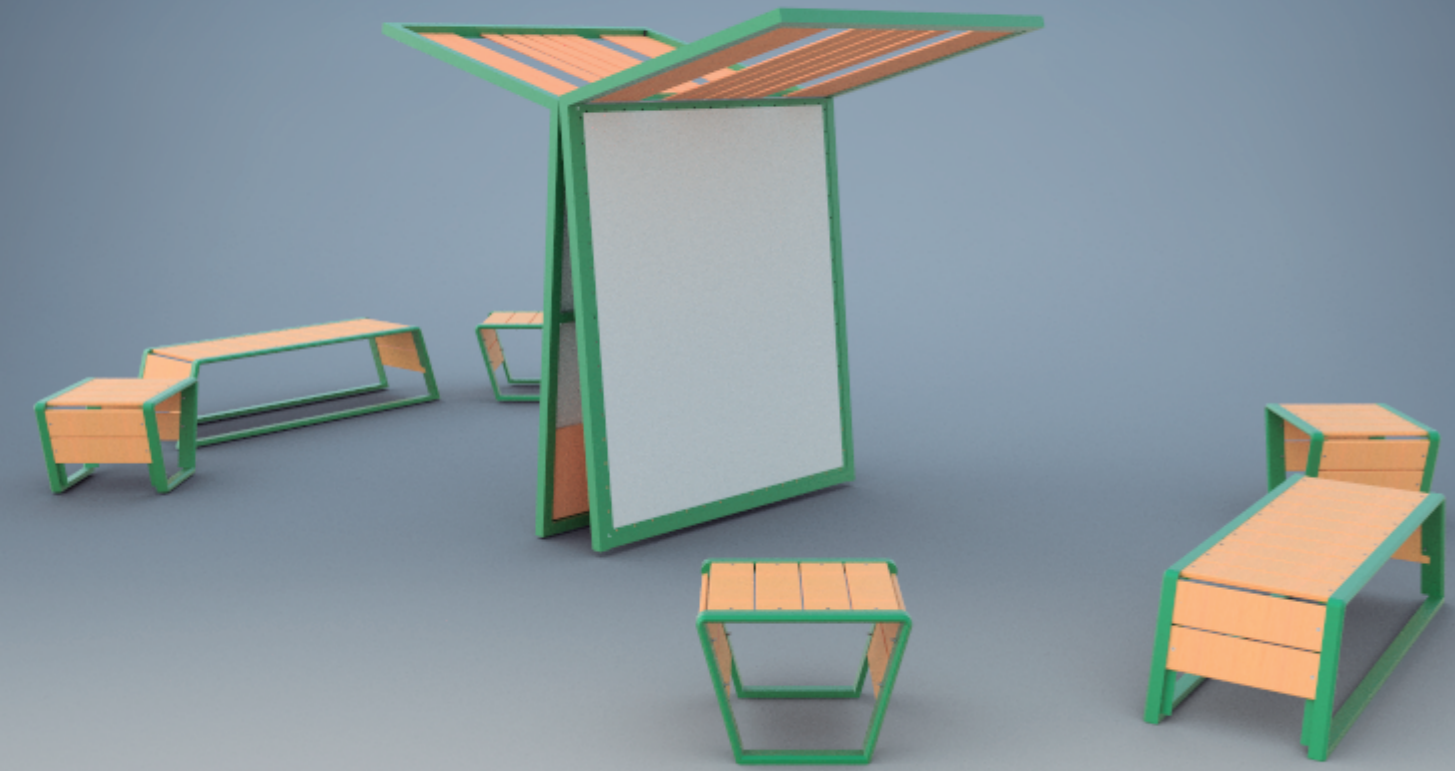



PROPUESTA 2

LÁMINAS TÉCNICAS

RENDERS

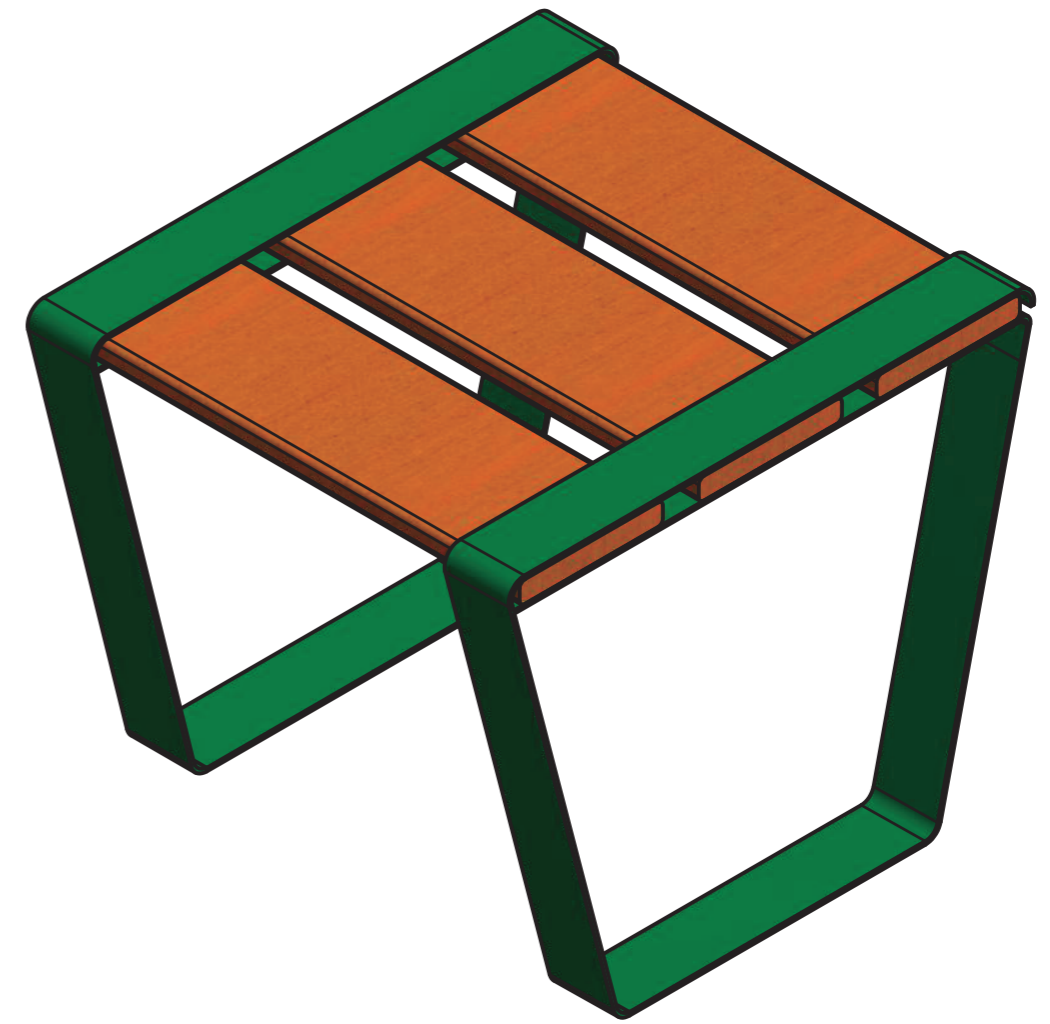
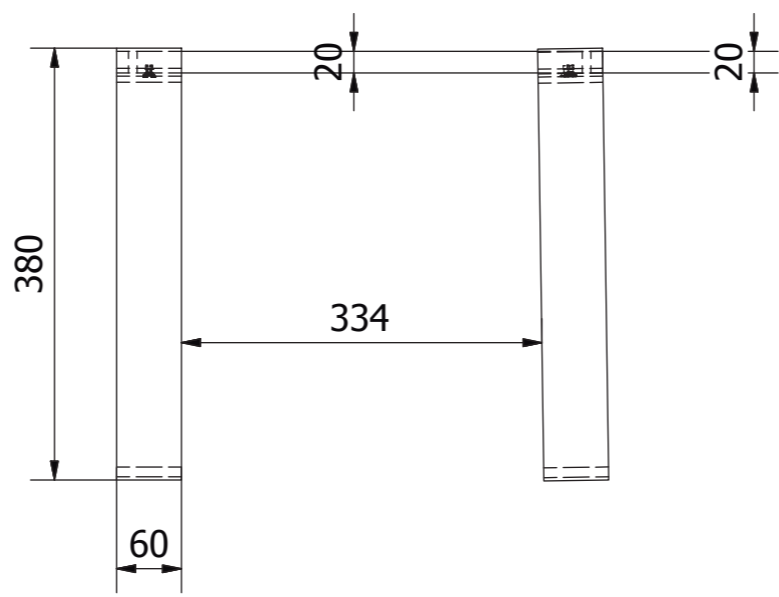
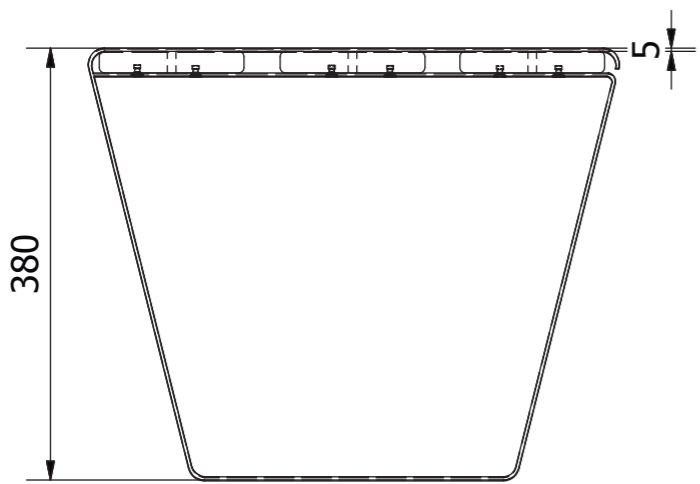
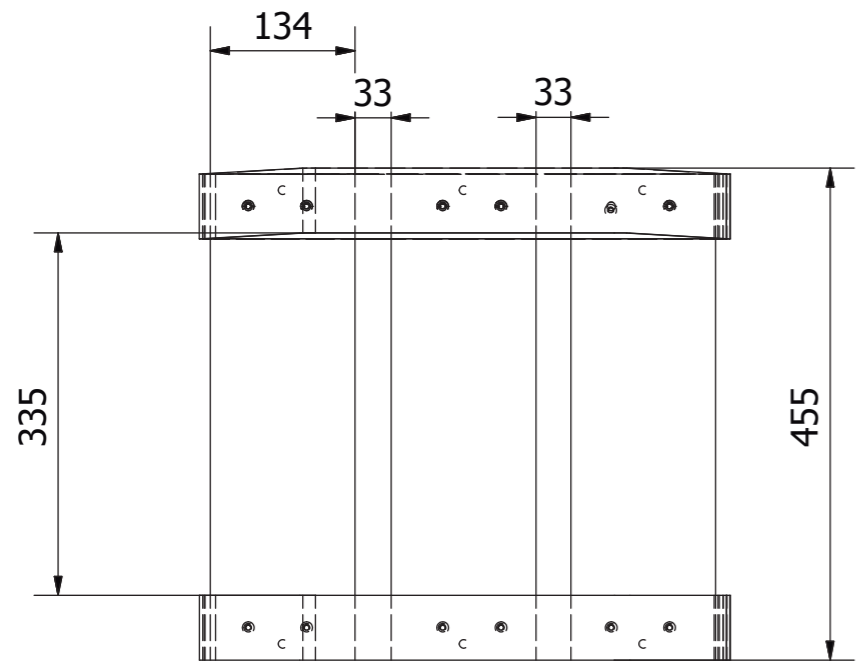

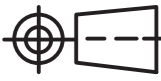
PUCE-FADA- DISEÑO		TFC DE DISEÑO DE PRODUCTOS		
Realizado por: Diego Guevara	Dimensiones: c m	Contiene: BANCA PEQUEÑA PROPUESTA 2	Escala: 1:20	
Revisado por: Mst. María Dolores Cevallos	Fecha: 19/07/2017			
CPE INEN 003 1989 ECUADOR				

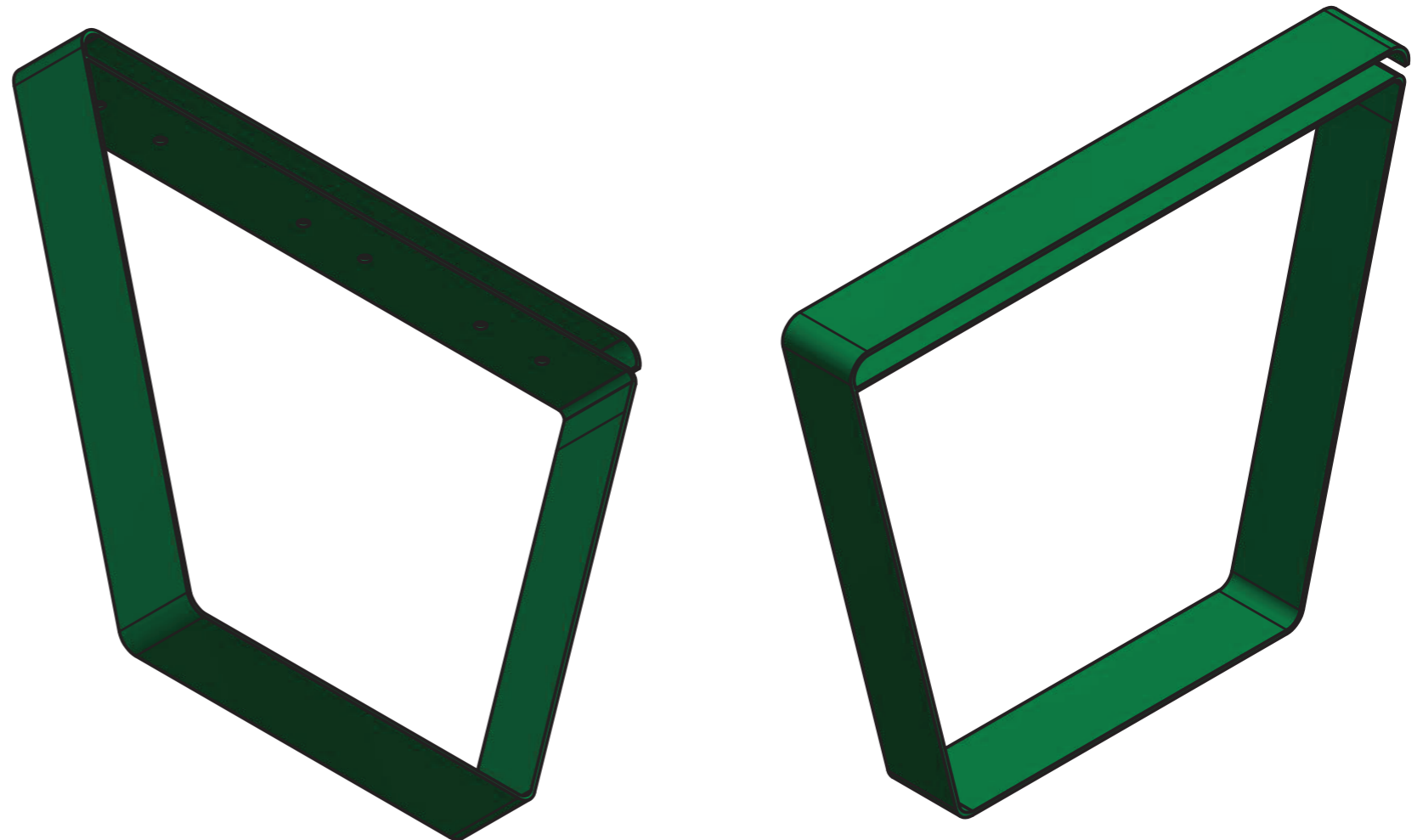
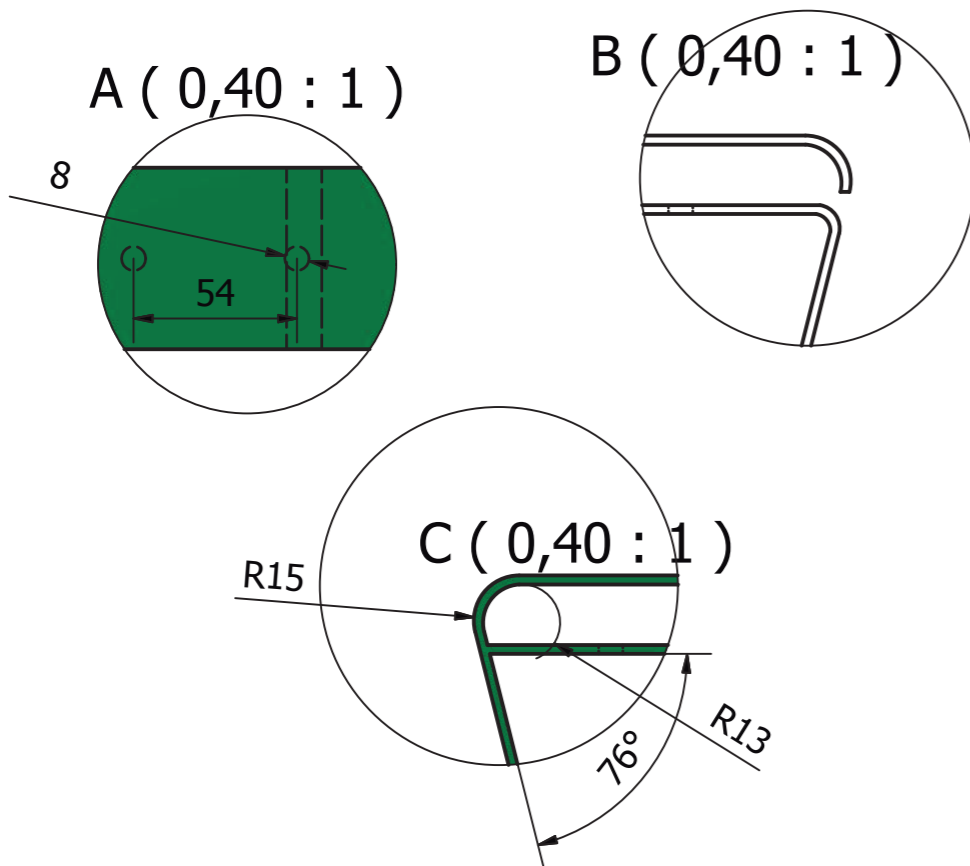
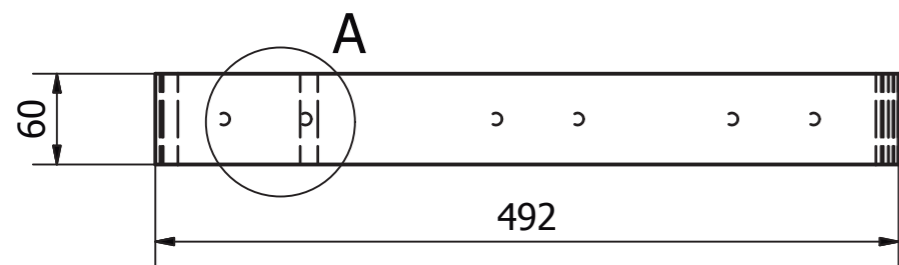
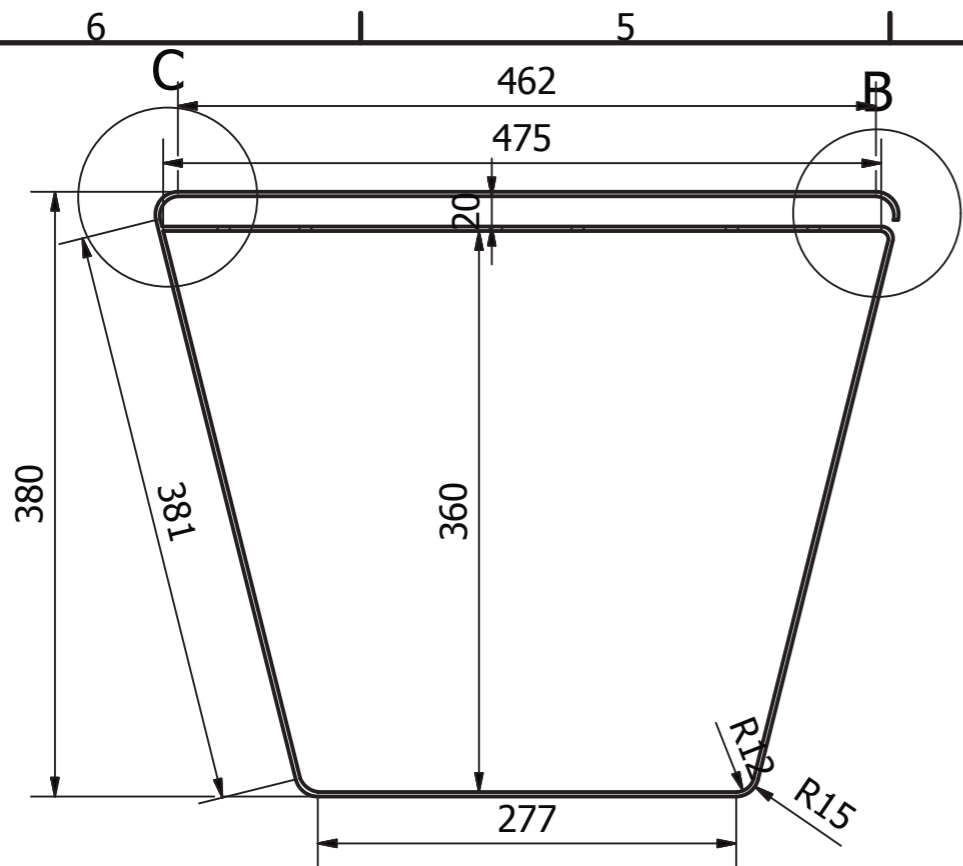

PUCE-FADA- DISEÑO		TFC DE DISEÑO DE PRODUCTOS		
Realizado por: Diego Guevara	Dimensiones: cm	Contiene: LATERAL DE BANCA PEQUEÑA	Escala: 1:20	
Revisado por: Mst. María Dolores Cevallos	Fecha: 19/07/2017			
CPE INEN 003 1989 ECUADOR				

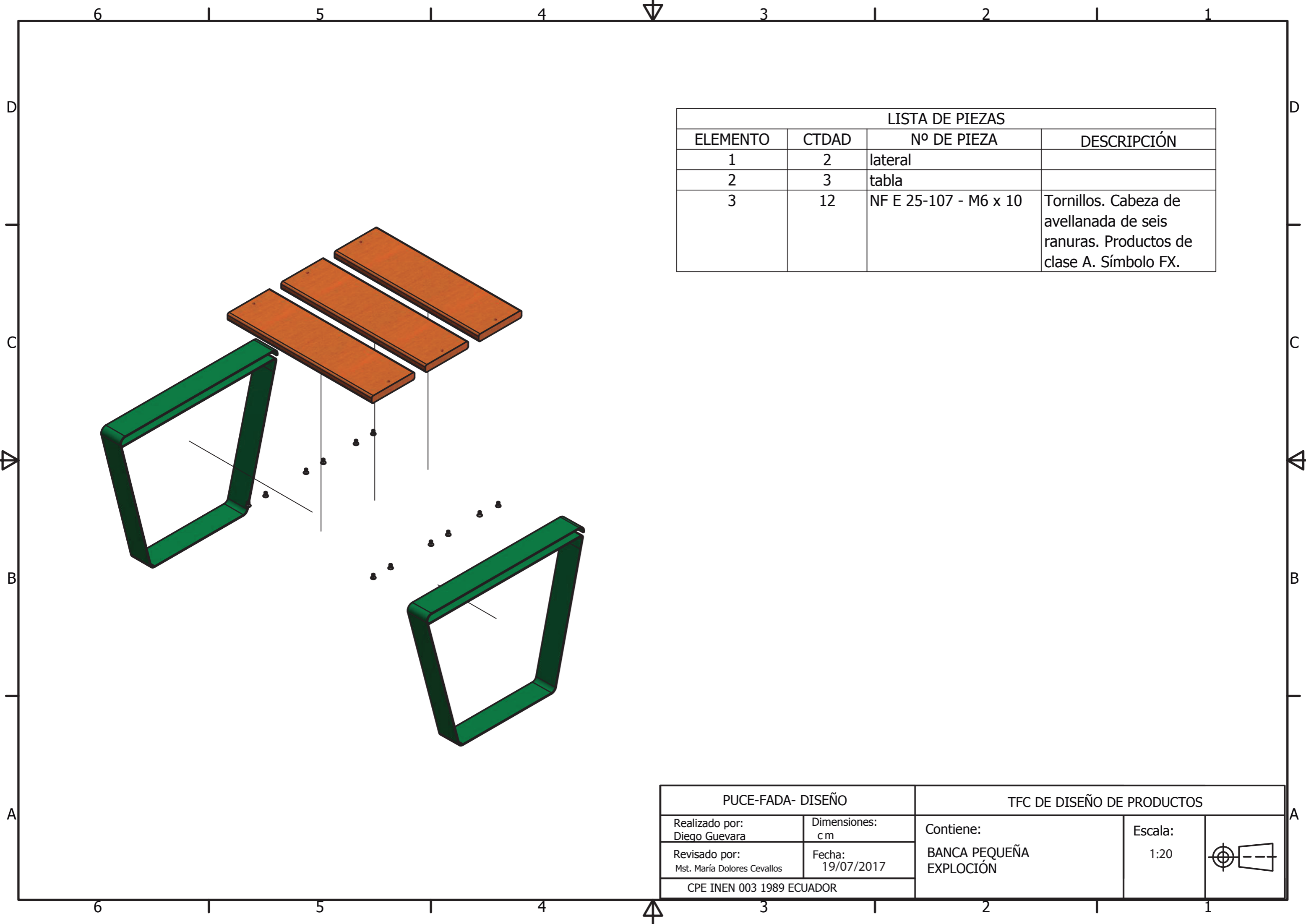

LISTA DE PIEZAS			
ELEMENTO	CTDAD	Nº DE PIEZA	DESCRIPCIÓN
1	2	lateral	
2	3	tabla	
3	12	NF E 25-107 - M6 x 10	Tornillos. Cabeza de avellanada de seis ranuras. Productos de clase A. Símbolo FX.

PUCE-FADA- DISEÑO		TFC DE DISEÑO DE PRODUCTOS		
Realizado por: Diego Guevara	Dimensiones: cm	Contiene: BANCA PEQUEÑA EXPLOCIÓN	Escala: 1:20	
Revisado por: Mst. María Dolores Cevallos	Fecha: 19/07/2017			
CPE INEN 003 1989 ECUADOR				

DETALLE DE IMPLANTACIÓN

Soldadura TIC, Tubo de 50mm a la estructura del tubo del mobiliario , con profundidad de 40 cm en una base de concreto de 50 cm x 50 cm x 30 cm.

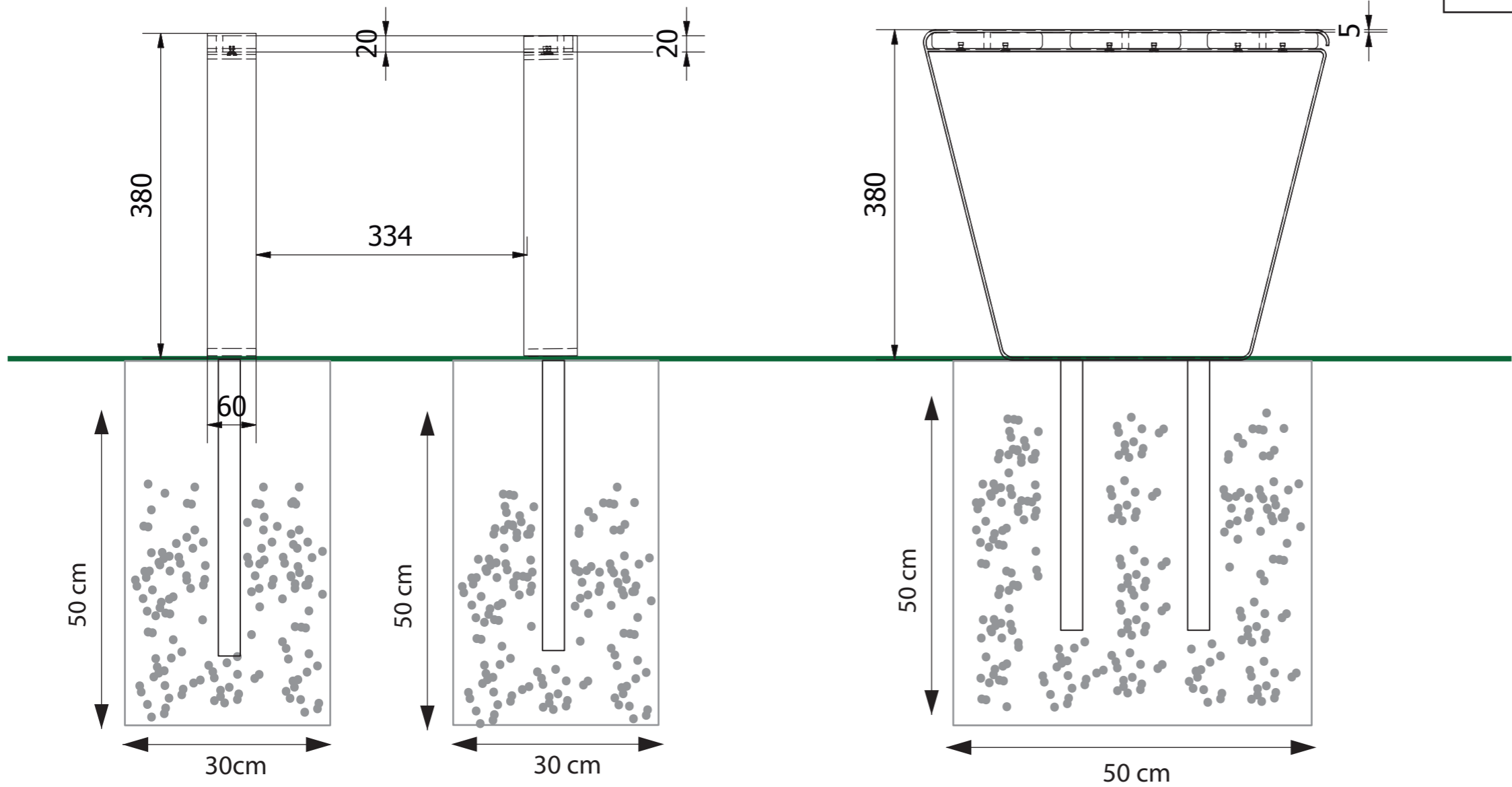

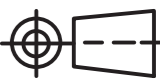
PUCE-FADA- DISEÑO		TFC DE DISEÑO DE PRODUCTOS		
Realizado por: Diego Guevara	Dimensiones: c m	Contiene: Implatación: Banca Unipersonal	Escala: 1:10	
Revisado por: Mst. María Dolores Cevallos	Fecha: 19/07/2017			
CPE INEN 003 1989 ECUADOR				

POSTURAS ANTROPOMÉTRICAS

POSTURA ALTURA RODILLA : 550 mm
 POSTURA ALTURA POPLITEA : 380 mm
 POSTURA ANCHURA DE CODOS: 620 mm

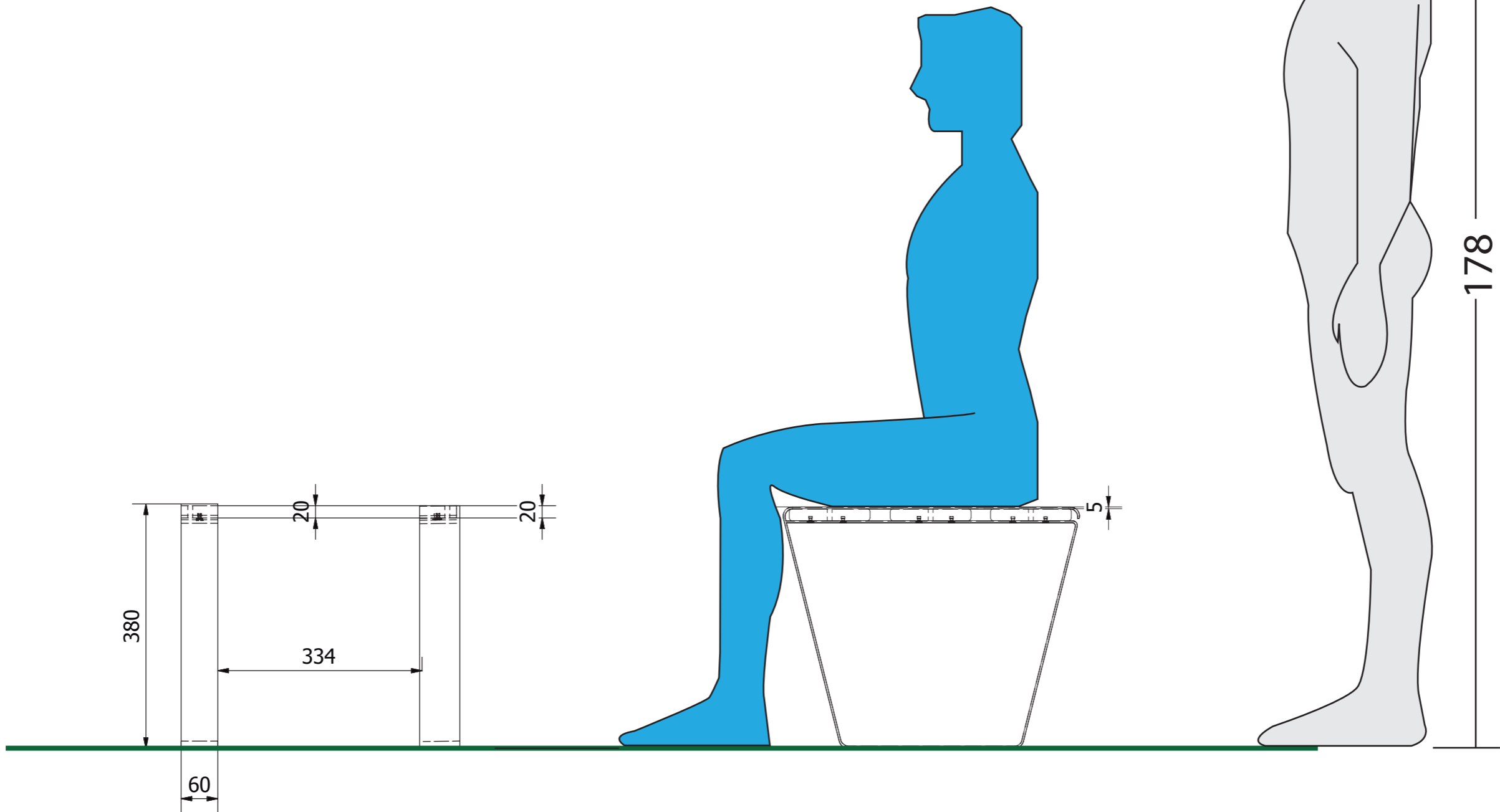

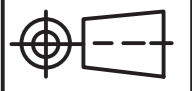
PUCE-FADA- DISEÑO		TFC DE DISEÑO DE PRODUCTOS		
Realizado por: Diego Guevara	Dimensiones: cm	Contiene: Análisis Antropométrico Banca Unipersonal	Escala: 1:10	
Revisado por: Mst. María Dolores Cevallos	Fecha: 19/07/2017			
CPE INEN 003 1989 ECUADOR				

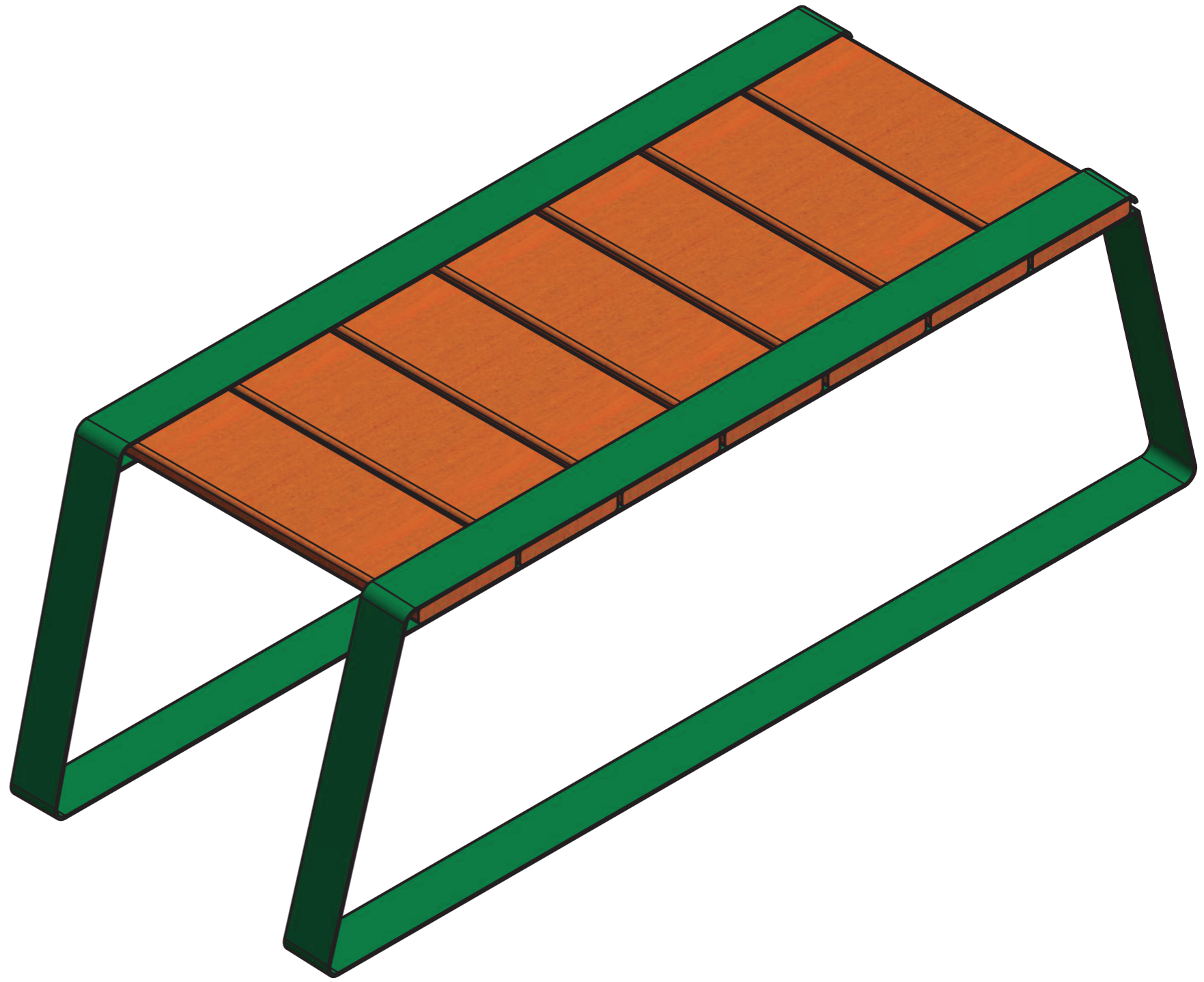
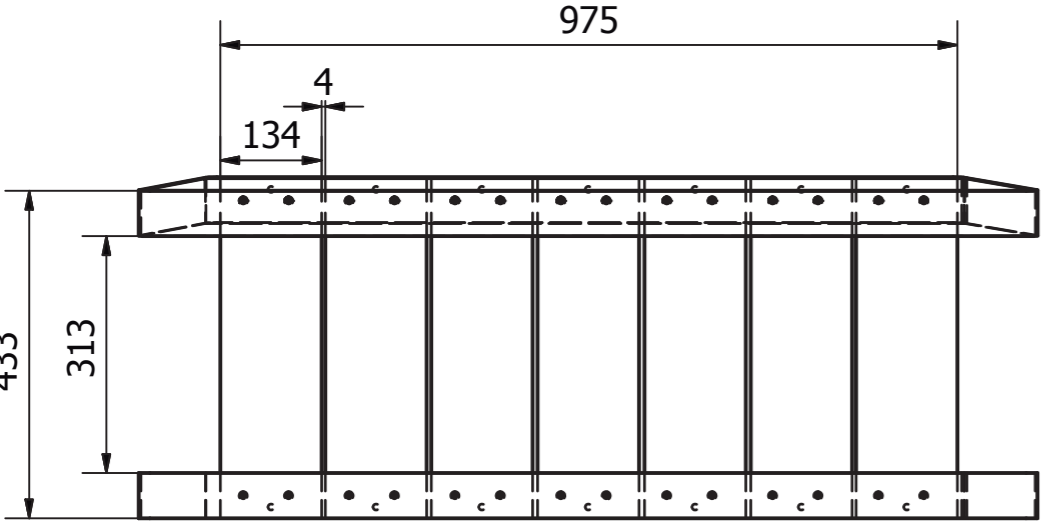
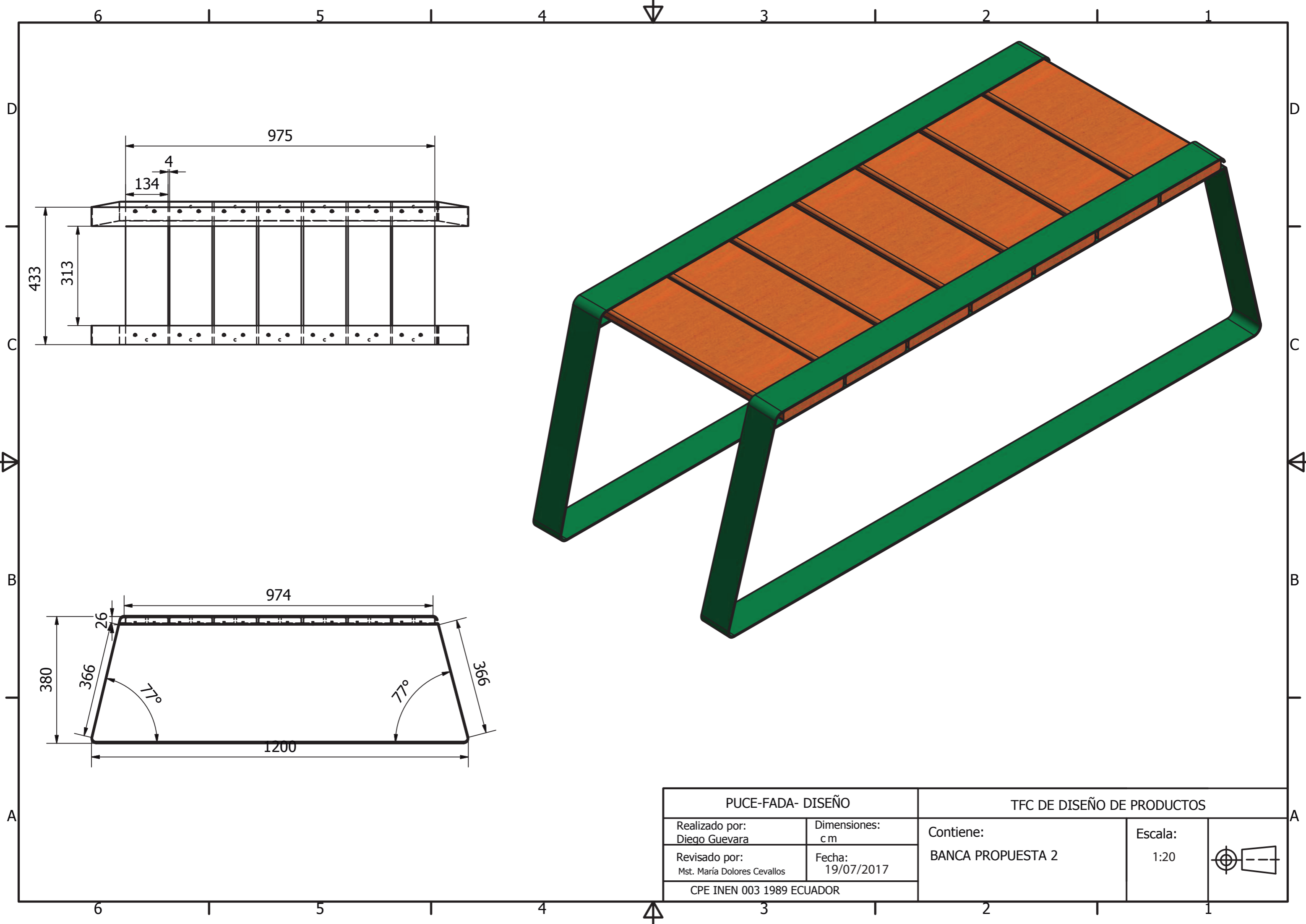

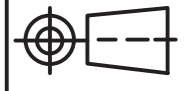
PUCE-FADA- DISEÑO		TFC DE DISEÑO DE PRODUCTOS		
Realizado por: Diego Guevara	Dimensiones: cm	Contiene: BANCA PROPUESTA 2	Escala: 1:20	
Revisado por: Mst. María Dolores Cevallos	Fecha: 19/07/2017			
CPE INEN 003 1989 ECUADOR				

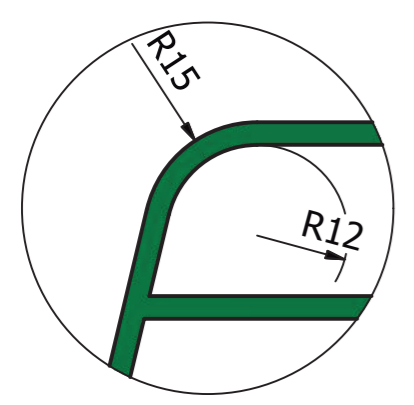
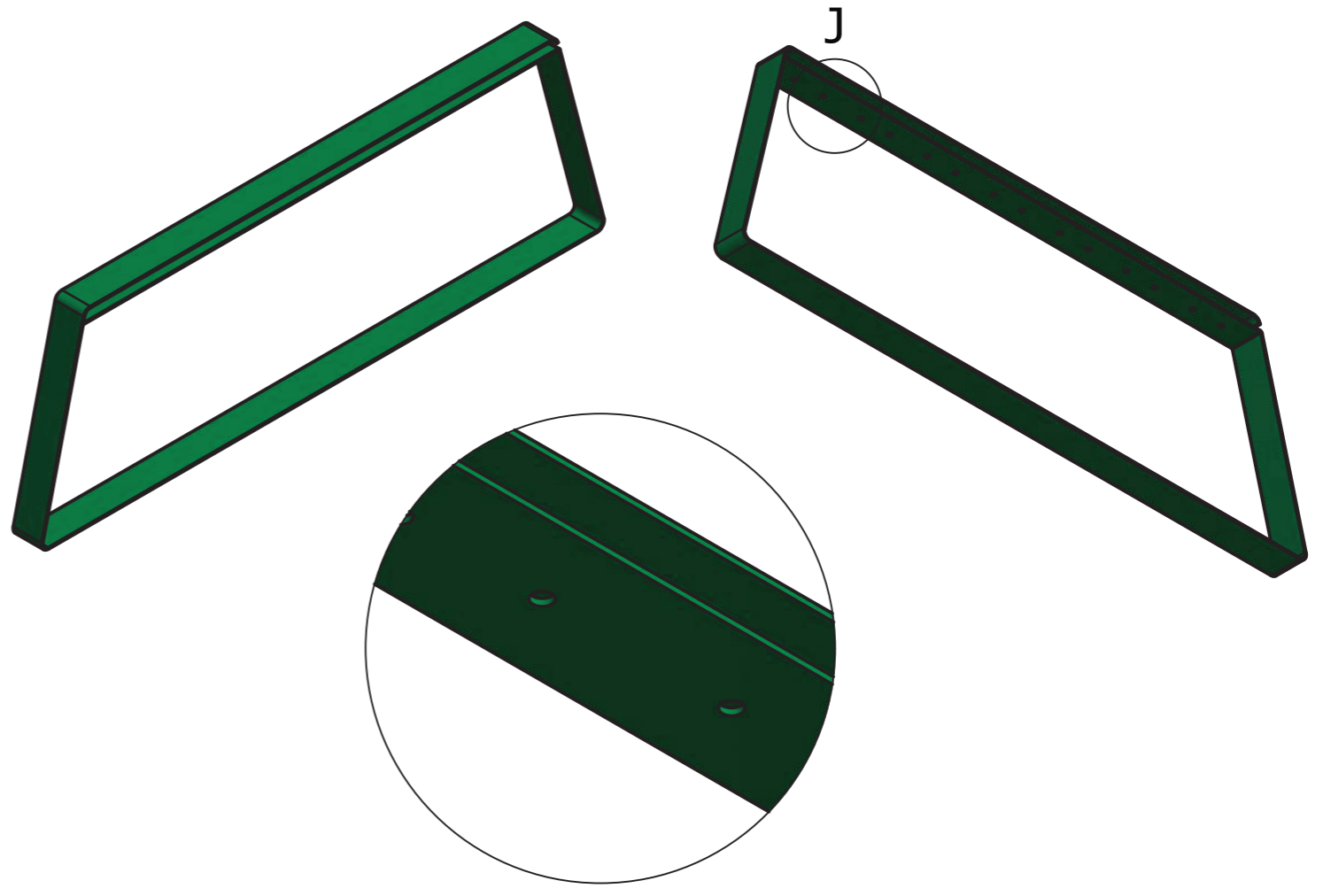
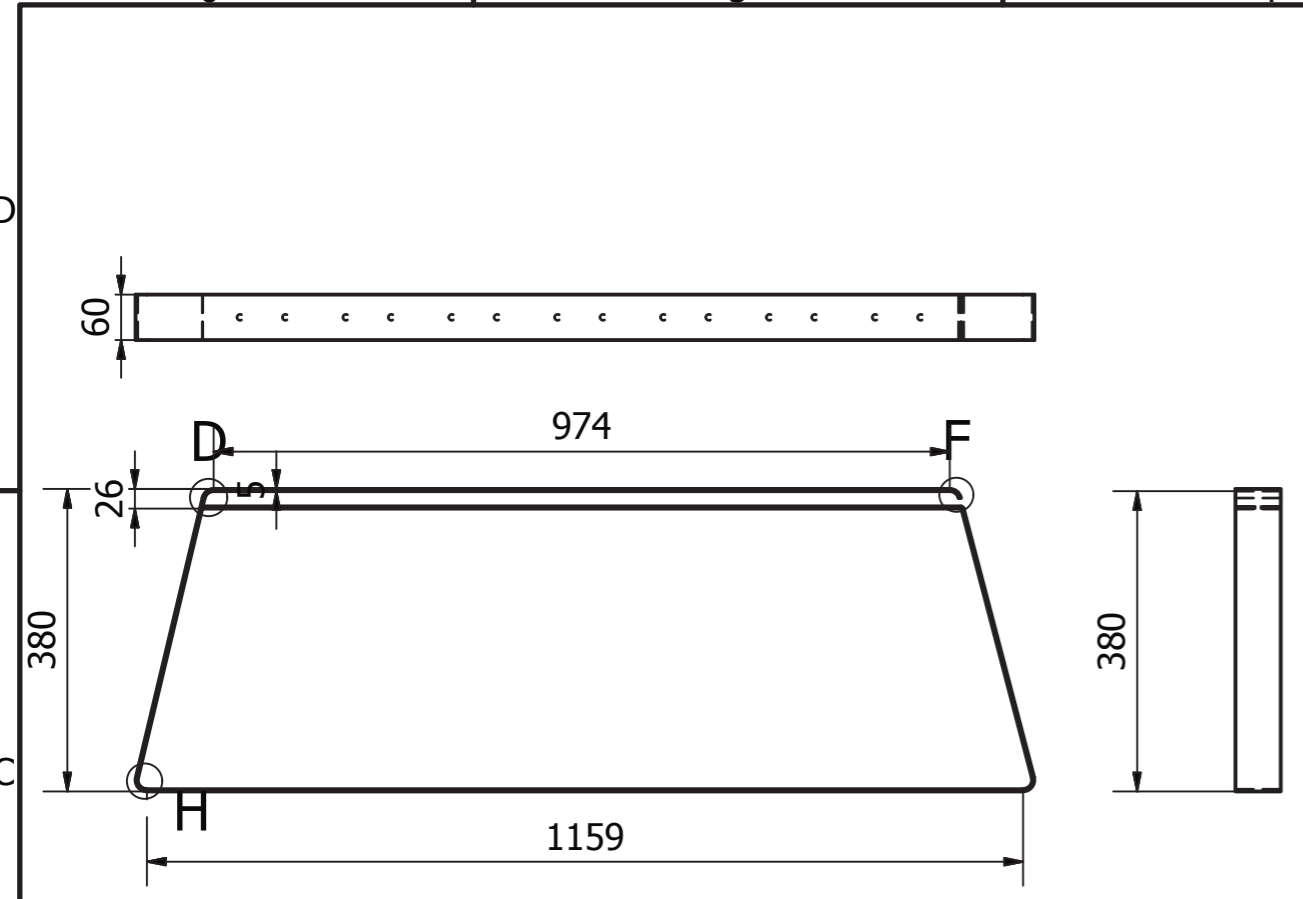

D (1:1)

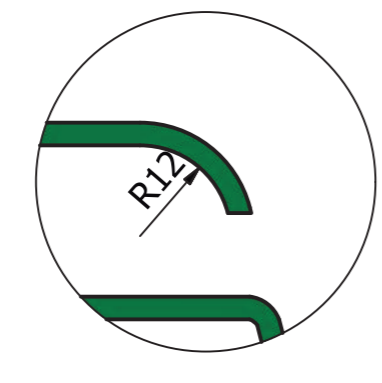

F (1:1)

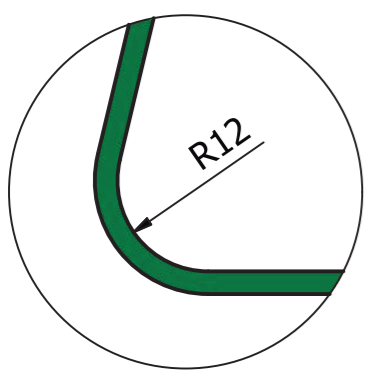

H (1:1)

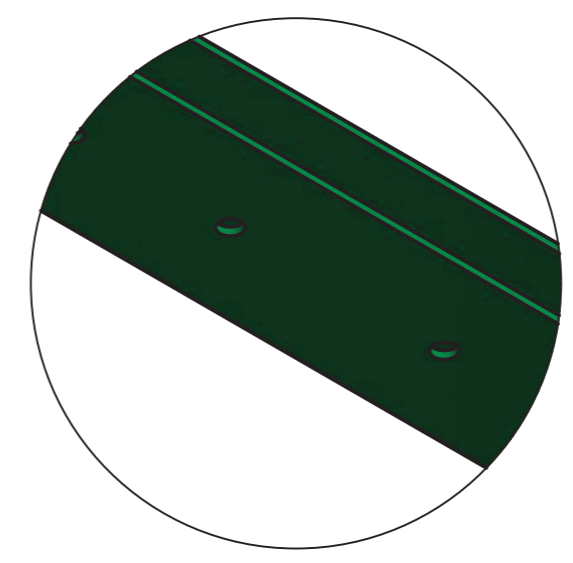

J (1:2)

PUCE-FADA- DISEÑO		TFC DE DISEÑO DE PRODUCTOS		
Realizado por: Diego Guevara	Dimensiones: c m	Contiene: LATERAL BANCA GRANDE	Escala: 1:20	
Revisado por: Mst. María Dolores Cevallos	Fecha: 19/07/2017			
CPE INEN 003 1989 ECUADOR				

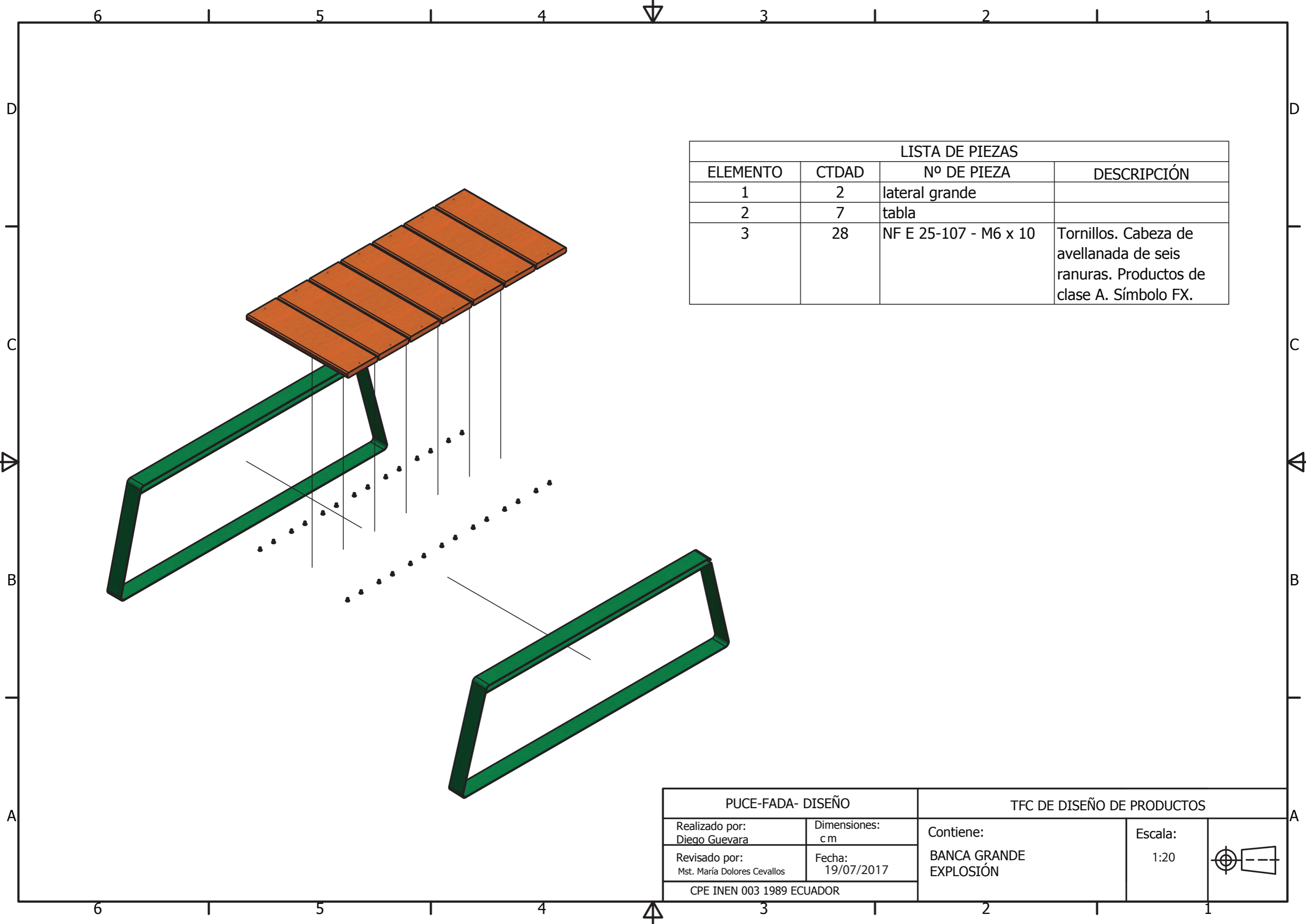

LISTA DE PIEZAS			
ELEMENTO	CTDAD	Nº DE PIEZA	DESCRIPCIÓN
1	2	lateral grande	
2	7	tabla	
3	28	NF E 25-107 - M6 x 10	Tornillos. Cabeza de avellanada de seis ranuras. Productos de clase A. Símbolo FX.

PUCE-FADA- DISEÑO		TFC DE DISEÑO DE PRODUCTOS		
Realizado por: Diego Guevara	Dimensiones: cm	Contiene: BANCA GRANDE EXPLOSIÓN	Escala: 1:20	
Revisado por: Mst. María Dolores Cevallos	Fecha: 19/07/2017			
CPE INEN 003 1989 ECUADOR				

DETALLE DE IMPLANTACIÓN

Soldadura TIC, Tubo de 50mm a la estructura del tubo del mobiliario , con profundidad de 40 cm en una base de concreto de 50 cm x 130 cm x 30 cm.

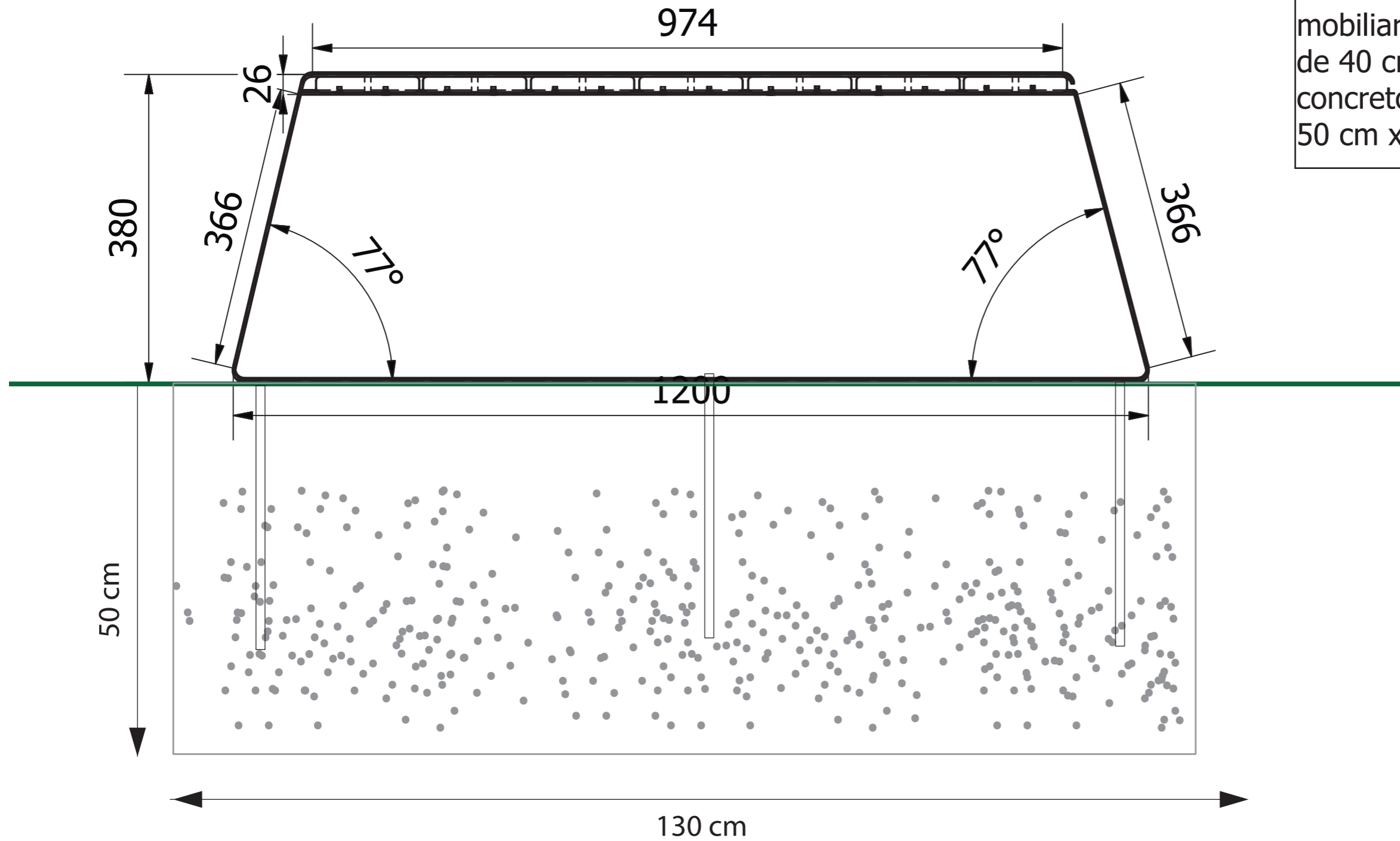

PUCE-FADA- DISEÑO		TFC DE DISEÑO DE PRODUCTOS		
Realizado por: Diego Guevara	Dimensiones: cm	Contiene: Implatación: Banca Corrida	Escala: 1:10	
Revisado por: Mst. María Dolores Cevallos	Fecha: 19/07/2017			
CPE INEN 003 1989 ECUADOR				

POSTURAS ANTROPOMÉTRICAS
 POSTURA ALTURA RODILLA : 550 mm
 POSTURA ALTURA POPLITEA : 380 mm
 POSTURA ANCHURA DE CODOS: 620 mm

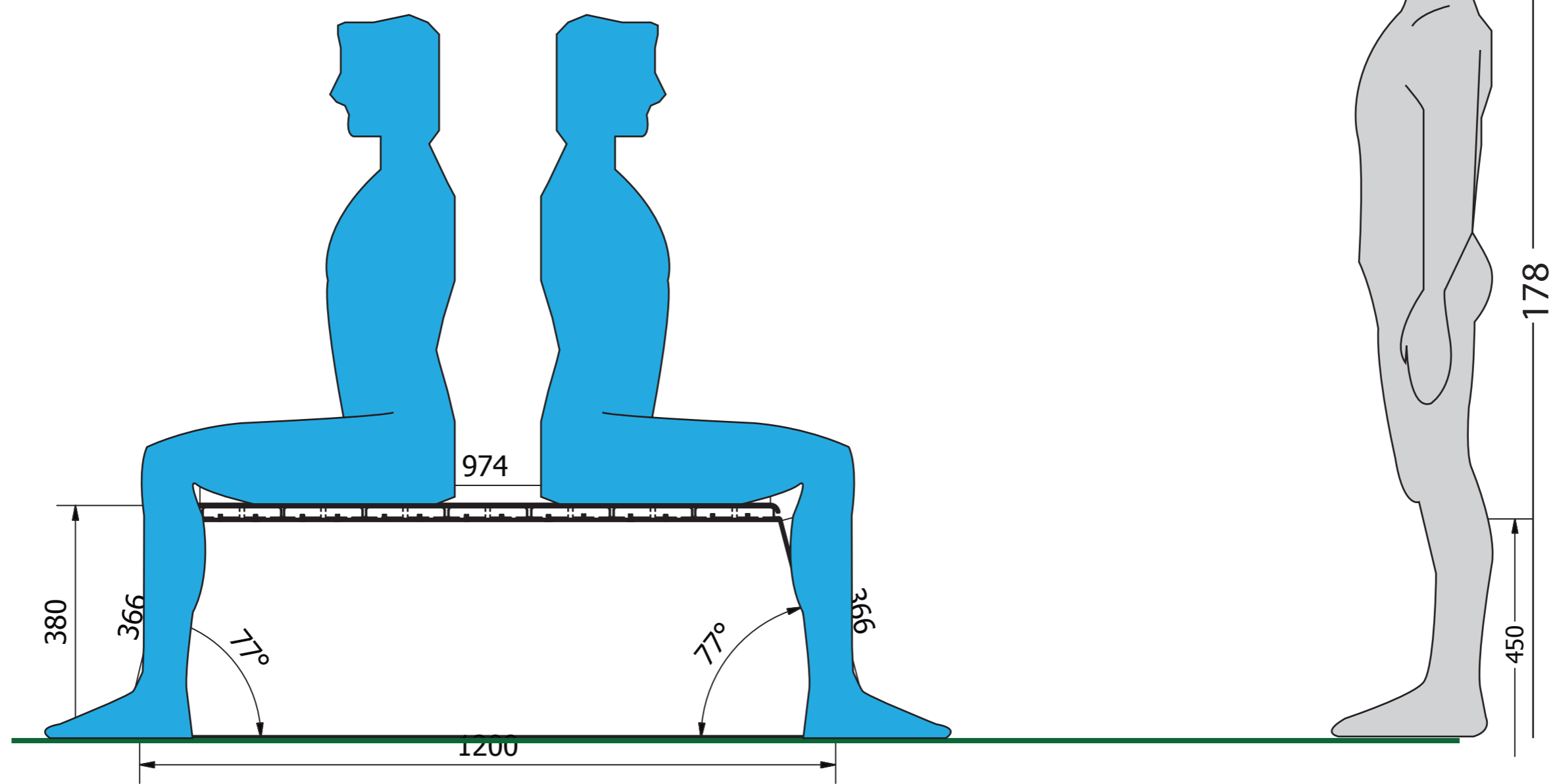

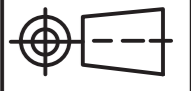
PUCE-FADA- DISEÑO		TFC DE DISEÑO DE PRODUCTOS		
Realizado por: Diego Guevara	Dimensiones: cm	Contiene: Análisis Antropométrico Banca Corrida	Escala: 1:10	
Revisado por: Mst. María Dolores Cevallos	Fecha: 19/07/2017			
CPE INEN 003 1989 ECUADOR				



RENDERS









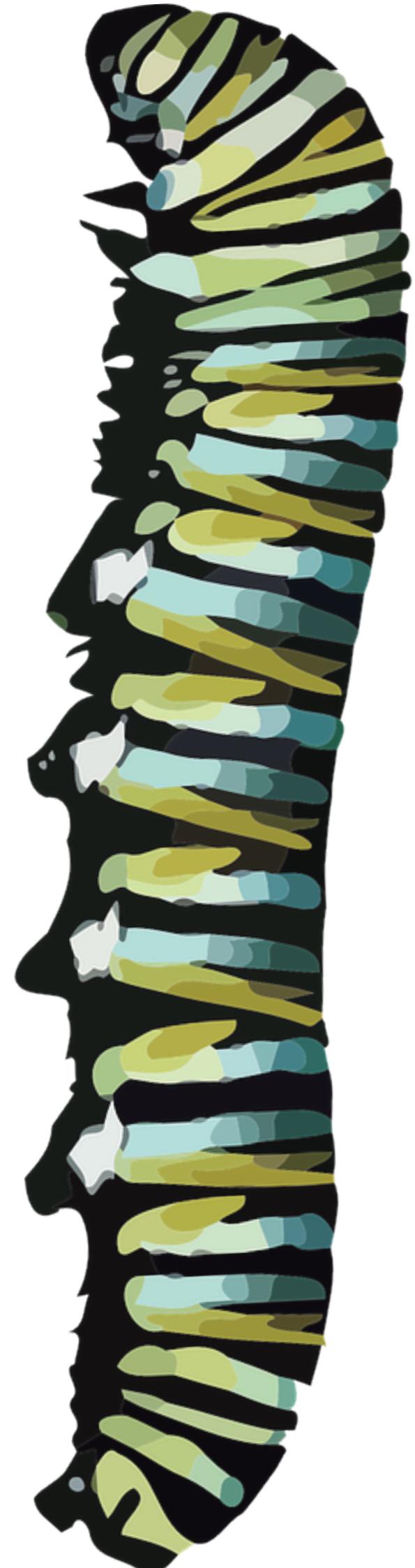

**PLANO DE POSIBLE
UBICACIÓN DEL
MOBILIARIO**

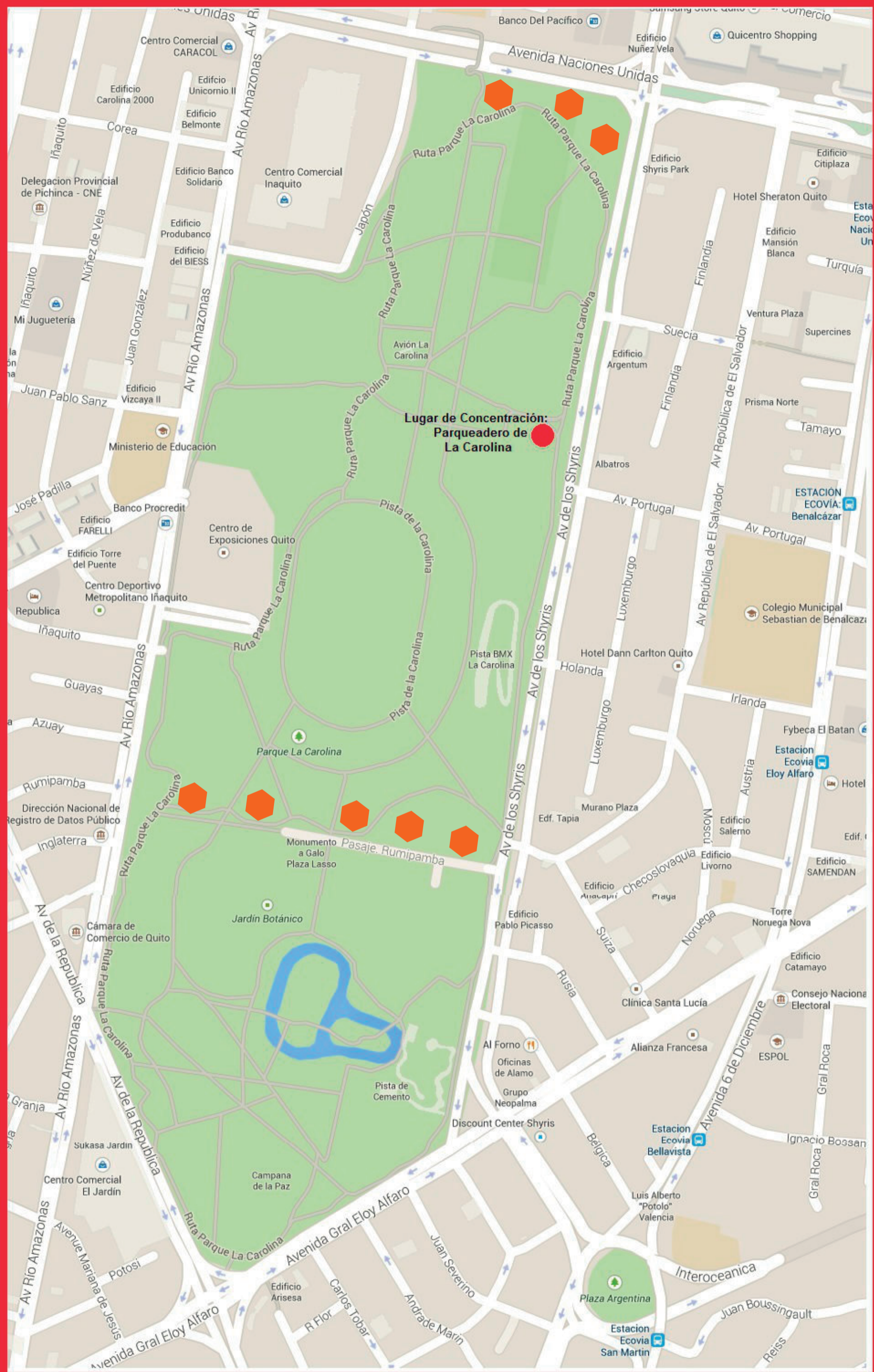

POSIBLE UBICACIÓN DEL MOBILIARIO